

THE NEW VALUE FRONTIER

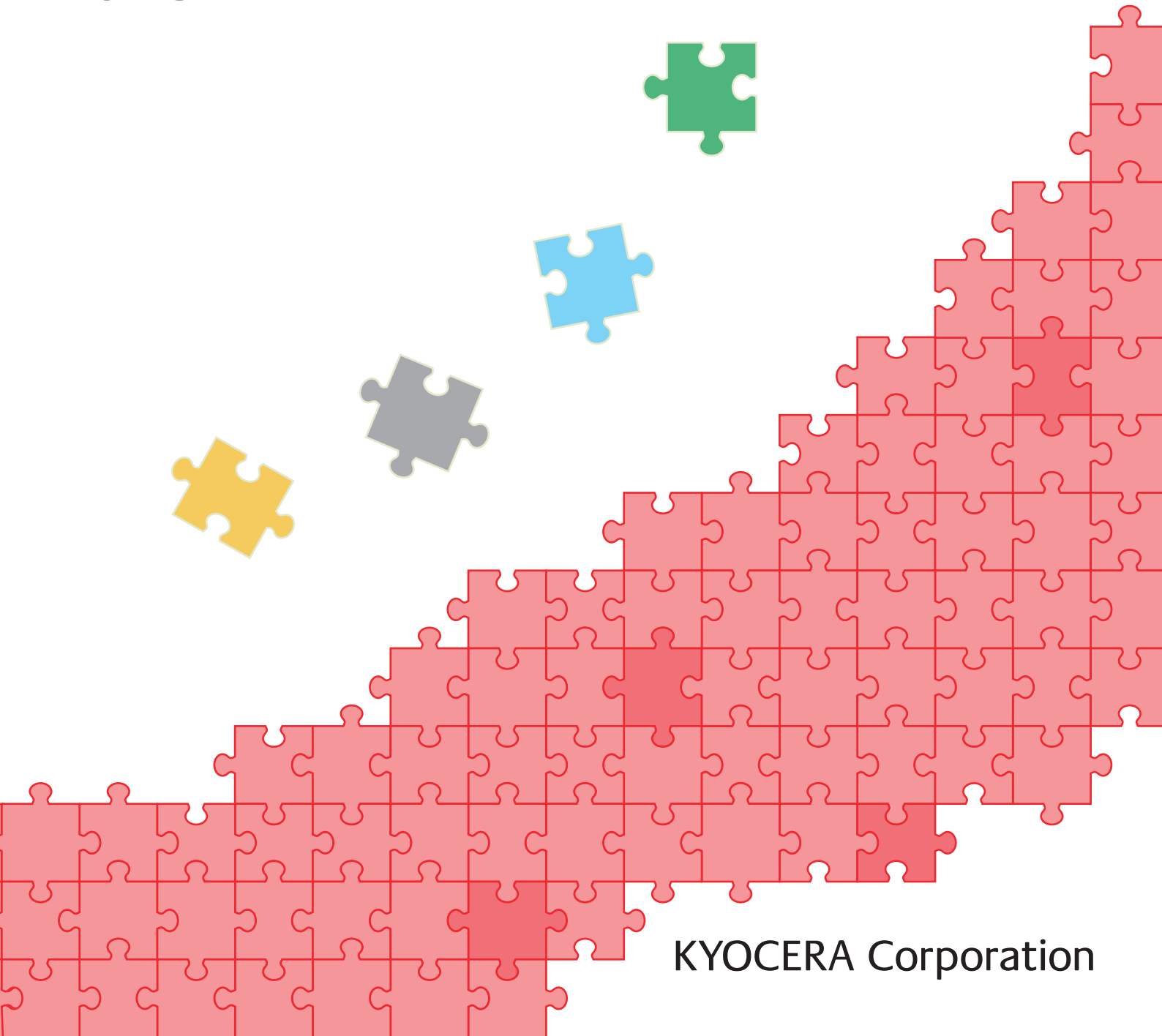

Capacitors 2019



KYOCERA Corporation

Capacitors

How to Order	1
Dimensions etc.	2
General CM Series	3 – 5
Low Profile CT Series	6
High-Q CU Series	7
Three Terminal Capacitors KNH Series	8
Test Conditions and Standards	9 – 11
Packaging	12 – 13
Precautions	14 – 17
Part Number List	18 – 21
Notes for Using the Catalog	22
Contact us	23

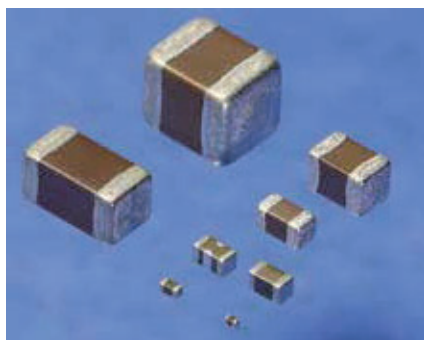

RoHS Compliant

■ Features

- Kyocera's series of Multilayer Ceramic Chip Capacitors are designed to meet a wide variety of needs. We offer a complete range of products for both general and specialized applications.
- We have a network worldwide in order to supply our global customer bases quickly and efficiently and to maintain our reputation as one of the highest-volume producers in the industry
- All our products are highly reliable due to their monolithic structure of high-purity and superfine uniform ceramics and their integral internal electrodes.
- By combining superior manufacturing technology and materials with high dielectric constants, we produce extremely compact components with exceptional specifications.
- Our stringent quality control in every phase of production from material procurement to shipping ensures consistent manufacturing and super quality.
- Kyocera components are available in a wide choice of dimensions, temperature characteristics, rated voltages, and terminations to meet specific configurational requirements.

■ KYOCERA PART NUMBER

CM 03 X5R 225 M 06 A H

① ② ③ ④ ⑤ ⑥ ⑦ ⑧ OPTION :

Above digits are used to track individual specification or thickness.

(Example)

- ① Series : CM Series(General)
- ② Size : 0201
- ③ Dielectric : X5R
- ④ Capacitance : 2.2 μ F
- ⑤ Tolerance : $\pm 20\%$
- ⑥ Voltage : 6.3Vdc
- ⑦ Termination : Sn
- ⑧ Packaging : Cavity pitch 2mm / Reel Size $\phi 180$

① SERIES CODE

CODE	Type
CM	General
CT	Low Profile
CU	High-Q
KNH	Three Terminal Capacitors

② SIZE CODE

CODE	EIA	JIS
02	01005	0402
03	0201	0603
05	0402	1005
105	0603	1608
21	0805	2012
316	1206	3216
32	1210	3225

③ DIELECTRIC CODE

Temperature Compensation Type			
CODE	Temperature Range (°C)	ppm/°C	
CG	-55 to 125	0	± 30
CH			± 60

- All parts of COG will be marked as "CG" but will conform to the above table.
- Temperature coefficients are determined by calculation based on measurement at 20°C and 85°C.

High Dielectric Constant Type			
CODE	Temperature Range (°C)	ΔC max. (%)	Standard Temperature (°C)
X5R	-55 to 85	± 15	25
X7R		± 15	
X7S	-55 to 125	± 22	

④ CAPACITANCE CODE

Capacitance expressed in pF.
Two significant digits plus number of zeros.
For Values < 10pF, Letter R denotes decimal point,
<1,000pF=1nF, 1,000nF=1 μ F>

(Example)

CODE	Capacitance	E STANDARD NUMBER			
		E3	E6	E12	E24
R50	0.5pF				
1R0	1pF				
100	10pF	1.0	1.0	1.0	1.1
101	100pF		1.5	1.5	1.6
102	1nF	1.5	1.8	1.8	2.0
103	10nF		2.2	2.2	2.4
104	100nF	2.2	2.7	2.7	3.0
105	1 μ F		3.3	3.3	3.6
106	10 μ F	3.3	3.9	3.9	4.3
			4.7	4.7	5.1
		4.7	5.6	5.6	6.2
			6.8	6.8	7.5
		6.8	8.2	8.2	9.1

⑤ TOLERANCE CODE

Temperature Compensation Type (COG)	
CODE	Tolerance
A*	± 0.05 pF
B	± 0.1 pF
C	± 0.25 pF
D	± 0.5 pF
G*	$\pm 2\%$
J	$\pm 5\%$
K	$\pm 10\%$

* : Option

⑥ VOLTAGE CODE

CODE	Rated Voltage
04	4Vdc
06	6.3Vdc
10	10Vdc
16	16Vdc
25	25Vdc
35	35Vdc
50	50Vdc
100	100Vdc

⑦ TERMINATION CODE

CODE	Termination
A	Nickel Barrier/ Tin

* : Please contact us if Au termination is needed.

⑧ PACKAGING CODE

CODE	Size Code	Cavity pitch	Reel size
T	105 to 32	4mm	$\phi 180$
H	02 to 05	2mm	
Q	03/05	1mm	
P	02	1mm	$\phi 330$
L	105 to 32	4mm	
N	02 to 05	2mm	
W	03/05	1mm	

High Dielectric Constant Type(X5R/X7R/X7S)	
CODE	Tolerance
J*	$\pm 5\%$
K	$\pm 10\%$
M	$\pm 20\%$

* : Option



Dimension

CM/CT/CU Series

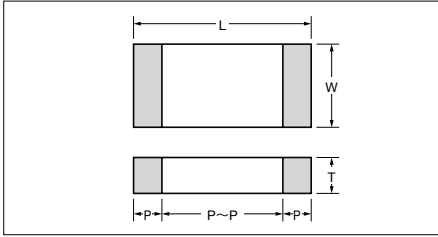

Packaging Code

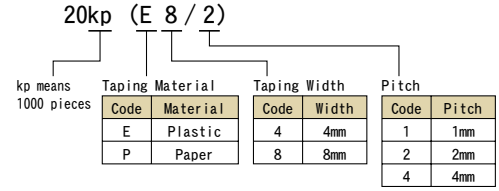

Size	Code		Dimension Code	Dimension (mm)						Quantity per reel	
	EIA	JIS		L	W	T	P min.	P max.	P to P min.	φ 180 Reel	φ 330 Reel
02	01005	0402	A	0.4±0.02	0.2±0.02	0.2±0.02	0.07	0.14	0.13	40kp(E4/1) 20kp(P8/2)	— 80kp(P8/2)
03	0201	0603	A	0.6±0.03	0.3±0.03	0.22 max.	0.10	0.20	0.20	30kp(P8/1) 15kp(P8/2)	150kp(P8/1) 50kp(P8/2)
			B			0.3±0.03					
			C			0.3±0.05					
			D			0.3±0.05					
05	0402	1005	A	1.0±0.05	0.5±0.05	0.22 max.	0.15	0.35	0.30	20kp(P8/1) 10kp(P8/2)	100kp(P8/1) 50kp(P8/2)
			B			0.33 max.					
			C			0.5±0.05					
			D			1.0±0.15					
105	0603	1608	A	1.6±0.10	0.8±0.10	0.55 max.	0.20	0.60	0.50	4kp(P8/4)	10kp(P8/4)
			B			0.8±0.10					
			C			0.8±0.15					
			D			0.8±0.20					
21	0805	2012	A	2.0±0.10	1.25±0.10	0.95 max.	0.20	0.75	0.70	4kp(P8/4) 3kp(E8/4) 4kp(P8/4) 3kp(E8/4) 4kp(P8/4) 3kp(E8/4)	10kp(P8/4) 10kp(E8/4) 10kp(P8/4) 10kp(E8/4) 10kp(P8/4) 10kp(E8/4)
			B			1.25±0.10					
			C			0.95 max.					
			D			1.25±0.15					
			E			0.95 max.					
			F			1.25±0.20					
316	1206	3216	A	3.2±0.20	1.6±0.15	0.30	0.85	1.40	2.5kp(E8/4)	5kp(E8/4)	
			B		1.6±0.20						
			C		1.6±0.30						
32	1210	3225	A	3.2±0.30	2.5±0.20	2.5±0.20	0.30	1.00	1.40	1kp(E8/4)	4kp(E8/4)

KNH Series

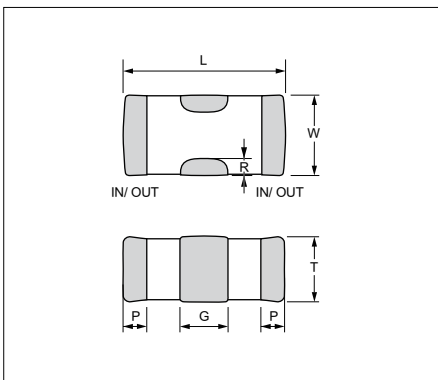

Size	Code		Dimension Code	Dimension (mm)						Packaging	
	EIA	JIS		L	W	T	G	P	R	φ 180 Reel	φ 330 Reel
KNH 05	0402	1005	A	1.0 ± 0.10	0.5 ± 0.20	0.5max.	0.3 ± 0.10	0.15 ± 0.10	≥ 0.05	10kp(P8/2)	—
			B	1.0 ± 0.15	0.5 ± 0.15	0.5 ± 0.15					
			C	1.0 ± 0.20	0.5 ± 0.20	0.5 ± 0.20					



■ Features

We offer a diverse product line ranging from ultra-compact (0.4 × 0.2mm) to large (3.2 × 2.5mm) components configured for a variety of temperature characteristics, rated voltages, and packages. We offer the choice and flexibility for almost any applications.

■ Applications

This standard type is ideal for use in a wide range of applications, from commercial to industrial equipment.

Temperature Compensation Dielectric

Part Number List : P18

● Capacitance chart ■ Standard Spec. ▨ Optional Spec.

Size (EIA Code)	CM02 (01005)		CM03 (0201)
	16	25	50
Rated Voltage (Vdc)			
Capacitance (pF)			
1R0			
1R5			
2.0			
3.0			
4.0			
5.0			
6.0			
7.0			
8.0			
9.0			
100			
120			
12			
15			
18			
22			
27			
33			
39			
47			
56			
68			
82			
101			
100			
121			
120			
150			
180			
220			

<Standard Capacitor Value : E12 Series>

Please contact for capacitance value other than standard.

Alphabets in capacitance chart denote dimensions. Please refer to the below table for detail.

(Example) In case of "B" for CM03 ;
L : 0.6 ± 0.03mm, W : 0.3 ± 0.03mm T : 0.3 ± 0.03mm

Size	Dimension Code	Dimension (mm)			Packaging									
					φ 180 Reel					φ 330 Reel				
		L	W	T	Code	Quantity	Taping Material	Taping Width	Cavity Pitch	Code	Quantity	Taping Material	Taping Width	Cavity Pitch
02	A	0.4 ± 0.02	0.2 ± 0.02	0.2 ± 0.02	P	40,000	Plastic	4mm	1mm	—	—	—	—	—
					H	20,000	Paper	8mm	2mm	N	80,000	Paper	8mm	2mm
03	B	0.6 ± 0.03	0.3 ± 0.03	0.3 ± 0.03	Q	30,000	Paper	8mm	1mm	W	150,000	Paper	8mm	1mm
					H	15,000	Paper	8mm	2mm	N	50,000	Paper	8mm	2mm



X5R Dielectric

Part Number List : P19-20

● Capacitance chart ■ Standard Spec. ▨ Optional Spec.

Size (EIA Code)	CM02 (01005)			CM03 (0201)					CM05 (0402)					CM105 (0603)			
	6.3	10	16	4	6.3	10	16	25	4	6.3	10	16	25	35	10	16	25
101 100 150 220 330			■														
102 470 680 1000			■ A8														
152 1500 2200 3300			■					■ B3									
103 4700 6800 10000			■														
153 15000 22000 33000	■ A8																
104 47000 68000 100000	▨ A8	▨ A8															
105 470000 1000000																	
106 4700000 10000000																	
15000000 22000000																	

Size (EIA Code)	CM21 (0805)				CM316 (1206)					CM32 (1210)						
	10	16	25	50	6.3	10	16	25	50	100	6.3	10	16	25	50	
105 1000000 2200000 4700000			■ B3	■ B8												
106 10000000 22000000 47000000	■ B4	■ B3 D8 F8	■ F8			■ A4	■ A3 B8	■ A3 B8	▨ B3	▨ B3				■ A3 A8	■ A3	

<Standard Capacitance Value>

Capacitance value of less than 0.1 μF : E6 Series

Capacitance value of 0.1 μF and larger : E3 Series

Please contact for capacitance value other than standard.

Two digits alphanumeric in capacitance chart denote dimensions and tan δ. Please refer to the above table for detail.

(Example) In case of "B3" for CM03 ;
L : 0.6±0.03mm, W : 0.3±0.03mm, T : 0.3±0.03mm, Tan δ : 5.0% max.

Tan δ Code	Tan δ
3	5.0%max.
4	7.0%max.
5	7.5%max.
7	10.0%max.
8	12.5%max.
9	15.0%max.
10	20.0%max.

Size	Dimension Code	Dimension (mm)			Packaging									
					φ 180 Reel					φ 330 Reel				
		L	W	T	Code	Quantity	Taping Material	Taping Width	Cavity Pitch	Code	Quantity	Taping Material	Taping Width	Cavity Pitch
02	A	0.4 ± 0.02	0.2 ± 0.02	0.2 ± 0.02	P	40,000	Plastic	4mm	1mm	—	—	—	—	—
					H	20,000	Paper	8mm	2mm	N	80,000	Paper	8mm	2mm
					Q	30,000	Paper	8mm	1mm	W	150,000	Paper	8mm	1mm
03	B	0.6 ± 0.03	0.3 ± 0.03	0.3 ± 0.03	H	15,000	Paper	8mm	2mm	N	50,000	Paper	8mm	2mm
					Q	30,000	Paper	8mm	1mm	W	150,000	Paper	8mm	1mm
					H	15,000	Paper	8mm	2mm	N	50,000	Paper	8mm	2mm
05	C	1.0 ± 0.05	0.5 ± 0.05	0.5 ± 0.05	Q	30,000	Paper	8mm	1mm	W	150,000	Paper	8mm	1mm
					H	15,000	Paper	8mm	2mm	N	50,000	Paper	8mm	2mm
					Q	20,000	Paper	8mm	1mm	W	100,000	Paper	8mm	1mm
105	B	1.6 ± 0.10	0.8 ± 0.10	0.8 ± 0.10	H	10,000	Paper	8mm	2mm	N	50,000	Paper	8mm	2mm
					H	10,000	Paper	8mm	2mm	N	50,000	Paper	8mm	2mm
					H	10,000	Paper	8mm	2mm	N	50,000	Paper	8mm	2mm
21	B	2.0 ± 0.10	1.25 ± 0.10	1.25 ± 0.10	T	4,000	Paper	8mm	4mm	L	10,000	Paper	8mm	4mm
					T	4,000	Paper	8mm	4mm	L	10,000	Paper	8mm	4mm
					T	4,000	Paper	8mm	4mm	L	10,000	Paper	8mm	4mm
316	D	1.6 ± 0.20	0.8 ± 0.20	0.8 ± 0.20	T	3,000	Plastic	8mm	4mm	L	10,000	Plastic	8mm	4mm
					T	3,000	Plastic	8mm	4mm	L	10,000	Plastic	8mm	4mm
					T	3,000	Plastic	8mm	4mm	L	10,000	Plastic	8mm	4mm
32	A	3.2 ± 0.20	1.6 ± 0.15	1.6 ± 0.15	T	2,500	Plastic	8mm	4mm	L	5,000	Plastic	8mm	4mm
					T	2,500	Plastic	8mm	4mm	L	5,000	Plastic	8mm	4mm
					T	1,000	Plastic	8mm	4mm	L	4,000	Plastic	8mm	4mm



X7R Dielectric

Part Number List : P19-20

● Capacitance chart ■ Standard Spec. ▨ Optional Spec.

Size (EIA Code)	CM02 (01005)	CM03 (0201)	CM05 (0402)	CM105 (0603)			CM21 (0805)				
Rated Voltage (Vdc) Capacitance (pF)	16	10	25	6.3	10	16	6.3	10	16	25	50
101 100	A8										
151 150											
220											
330											
102 470											
680											
1000											
152 1500		B3									
2200											
3300											
103 4700											
6800											
10000											
153 15000											
22000											
33000											
104 47000											
68000											
100000											
105 220000											
470000											
1000000											
106 2200000											
4700000											
10000000											

Size (EIA Code)	CM316 (1206)					CM32 (1210)		
Rated Voltage (Vdc) Capacitance (pF)	6.3	10	16	25	50	16	25	50
106 2200000								
4700000								
10000000								
22000000								

Tan δ Code	Tan δ
2	3.5%max.
3	5.0%max.
5	7.5%max.
8	12.5%max.

<Standard Capacitance Value>

Capacitance value of less than 0.1μF: E6 Series

Capacitance value of 0.1μF and larger: E3 Series

Please contact for capacitance value other than standard.

Two digits alphanumeric in capacitance chart denote dimensions and tan δ. Please refer to the above table for detail.

(Example) In case of "B3" for CM03 ;
L : 0.6±0.03mm, W : 0.3±0.03mm, T : 0.3±0.03mm, Tan δ : 5.0% max.

Size	Dimension Code	Dimension (mm)			Packaging									
					φ 180 Reel					φ 330 Reel				
		L	W	T	Code	Quantity	Taping Material	Taping Width	Cavity Pitch	Code	Quantity	Taping Material	Taping Width	Cavity Pitch
02	A	0.4 ± 0.02	0.2 ± 0.02	0.2 ± 0.02	P	40,000	Plastic	4mm	1mm	—	—	—	—	—
					H	20,000	Paper	8mm	2mm	N	80,000	Paper	8mm	2mm
03	B	0.6 ± 0.03	0.3 ± 0.03	0.3 ± 0.03	Q	30,000	Paper	8mm	1mm	W	150,000	Paper	8mm	1mm
					H	15,000	Paper	8mm	2mm	N	50,000	Paper	8mm	2mm
05	C	1.0 ± 0.05	0.5 ± 0.05	0.5 ± 0.05	Q	20,000	Paper	8mm	1mm	W	100,000	Paper	8mm	1mm
					H	10,000	Paper	8mm	2mm	N	50,000	Paper	8mm	2mm
105	B	1.6 ± 0.10	0.8 ± 0.10	0.8 ± 0.10	T	4,000	Paper	8mm	4mm	L	10,000	Paper	8mm	4mm
					T	4,000	Paper	8mm	4mm	L	10,000	Paper	8mm	4mm
21	B	2.0 ± 0.10	1.25 ± 0.10	1.25 ± 0.10	T	3,000	Plastic	8mm	4mm	L	10,000	Plastic	8mm	4mm
					T	3,000	Plastic	8mm	4mm	L	10,000	Plastic	8mm	4mm
316	B	3.2 ± 0.20	1.6 ± 0.20	1.6 ± 0.20	T	2,500	Plastic	8mm	4mm	L	5,000	Plastic	8mm	4mm
					T	2,500	Plastic	8mm	4mm	L	5,000	Plastic	8mm	4mm
32	A	3.2 ± 0.30	2.5 ± 0.20	2.5 ± 0.20	T	1,000	Plastic	8mm	4mm	L	4,000	Plastic	8mm	4mm
					T	1,000	Plastic	8mm	4mm	L	4,000	Plastic	8mm	4mm

X7S Dielectric

Part Number List : P20

● Capacitance chart ▨ Optional Spec.

Size (EIA Code)	CM316 (1206)
Rated Voltage (Vdc) Capacitance (pF)	100
105 1000000	
2200000	
4700000	
106 10000000	

Two digits alphanumeric in capacitance chart denote dimensions and tan δ. Please refer to the above table for detail.

(Example) In case of "B3" for CM316 ;
L : 3.2±0.20mm, W : 1.6±0.20mm, T : 1.6±0.20mm, Tan δ : 5.0% max.

Tan δ Code	Tan δ
3	5.0%max.

Size	Dimension Code	Dimension (mm)			Packaging									
					φ 180 Reel					φ 330 Reel				
		L	W	T	Code	Quantity	Taping Material	Taping Width	Cavity Pitch	Code	Quantity	Taping Material	Taping Width	Cavity Pitch
316	B	3.2 ± 0.20	1.6 ± 0.20	1.6 ± 0.20	T	2,500	Plastic	8mm	4mm	L	5,000	Plastic	8mm	4mm
					T	2,000	Plastic	8mm	4mm	—	—	—	—	—



Low Profile CT Series

【RoHS Compliant Products】

■ Features

This low profile series is ideal where height clearance is limited

■ Applications

Circuits requiring a compact, low-profile design, such as module and memory cards.

X5R Dielectric

Part Number List : P21

● Capacitance chart ■ Standard Spec. ▨ Optional Spec.

Size (EIA Code)	CT03 (0201)	CT05 (0402)	CT105 (0603)	CT21 (0805)		
Rated Voltage (Vdc)	6.3	6.3	16	16	25	50
Capacitance (pF)	6.3	6.3	16	16	25	50
104 100000 220000 470000	■ A8					
105 1000000 2200000 4700000	▨ D8 ▨	▨ A8/B8 ▨	■ A8		■ A3	
106 10000000		▨ B8 ▨ ▨ E9 ▨		■ C3		■ E3

<Standard Capacitor Value : E3 Series>

Please contact for capacitance value other than standard.

Two digits alphanumeric in capacitance chart denote dimensions and tan δ. Please refer to the above table for detail.

Tan δ Code	Tan δ
3	5.0%max.
8	12.5%max.
9	15.0%max.

(Example) In case of "A8" for CT03 ;
L : 0.6±0.03mm, W : 0.3±0.03mm, T : 0.22mm max., Tan δ : 12.5%max.

Size	Dimension Code	Dimension (mm)			Packaging										
		L	W	T	φ 180 Reel					φ 330 Reel					
					Code	Quantity	Taping Material	Taping Width	Cavity Pitch	Code	Quantity	Taping Material	Taping Width	Cavity Pitch	
03	A	0.6 ± 0.03	0.3 ± 0.03	0.22max.	Q	30,000	Paper	8mm	1mm	1mm	W	150,000	Paper	8mm	1mm
	D	0.6 ± 0.09	0.3 ± 0.09	0.25max.	H	15,000	Paper	8mm	2mm	2mm	N	50,000	Paper	8mm	2mm
05	A	1.0 ± 0.05	0.5 ± 0.05	0.22max.	Q	20,000	Paper	8mm	1mm	1mm	W	100,000	Paper	8mm	1mm
	H				H	10,000	Paper	8mm	2mm	2mm	N	50,000	Paper	8mm	2mm
	B	1.0 ± 0.05	0.5 ± 0.05	0.33max.	Q	20,000	Paper	8mm	1mm	1mm	W	100,000	Paper	8mm	1mm
	H				H	10,000	Paper	8mm	2mm	2mm	N	50,000	Paper	8mm	2mm
	E	1.0 ± 0.20	0.5 ± 0.20	0.33max.	H	10,000	Paper	8mm	2mm	2mm	—	—	—	—	
105	A	1.6 ± 0.10	0.8 ± 0.10	0.55max.	T	4,000	Paper	8mm	4mm	4mm	L	10,000	Paper	8mm	4mm
21	A	2.0 ± 0.10	1.25 ± 0.10	0.95max.	T	4,000	Paper	8mm	4mm	4mm	L	10,000	Paper	8mm	4mm
	C	2.0 ± 0.15	1.25 ± 0.15	0.95max.	T	4,000	Paper	8mm	4mm	4mm	L	10,000	Paper	8mm	4mm
	E	2.0 ± 0.20	1.25 ± 0.20	0.95max.	T	4,000	Paper	8mm	4mm	4mm	L	10,000	Paper	8mm	4mm



High-Q CU Series

【RoHS Compliant Products】

■ Features

Ultra-miniature size (0.4x0.2mm)
Low loss characteristics suitable for high frequency

■ Applications

● RF power amplifier for mobiles such as impedance matching purpose.

Temperature Compensation Dielectric

Part Number List : P21

● Capacitance chart ■ Standard Spec. ▨ Optional Spec.

Size (EIA Code)	CU02 (01005)	
	16	25
Rated Voltage (Vdc)		
Capacitance (pF)		
R20		
R50		
1R0		
1R5		
2.0		
3.0		
4.0		
5.0		
6.0		
7.0		
8.0		
9.0		
100		
120		
15		
18		
22		

<Standard Capacitor Value : E12 Series>

Please contact for capacitance value other than standard.

Alphabets in capacitance chart denote dimensions. Please refer to the below table for detail.

(Example) In case of "A" for CU02 ;
L : 0.4±0.02mm, W : 0.2±0.02mm, T : 0.2±0.02mm

Size	Dimension Code	Dimension (mm)			Packaging									
					φ 180 Reel					φ 330 Reel				
		L	W	T	Code	Quantity	Taping Material	Taping Width	Cavity Pitch	Code	Quantity	Taping Material	Taping Width	Cavity Pitch
02	A	0.4 ± 0.02	0.2 ± 0.02	0.2 ± 0.02	P	40,000	Plastic	4mm	1mm	—	—	—	—	—
					H	20,000	Paper	8mm	2mm	N	80,000	Paper	8mm	2mm



Three Terminal Capacitors

KNH Series

【RoHS Compliant Products】

■ Features

0402 Size. Rated current up to 2A MAX.
With unique circuit structure, this three terminal capacitor enables noise reduction in wide frequency range. With its high capacitance, it is possible to reduce the number of components being used.

■ Applications

- PCs, Laser Printers, Cellular Phone, Power/ Signal Lines for LCD Display, Office Equipments
- V Power Supply/ Signal Line, TV, VCR, etc.
- High Current Signal Lines

X5R Dielectric

Part Number List : P21

● Capacitance chart : Optional Spec.

Size (EIA Code)	KNH05 (0402)
Rated Voltage (Vdc)	4
Capacitance (pF)	
105 1000000	
435 4300000	A
106 10000000	C
156 15000000	B

Please contact for capacitance value other than standard

- Storage condition
- Temperature: -10 to +45°C
- Humidity: 45 to 75%RH

Alphabets in capacitance chart denote dimensions. Please refer to the below table for detail.

(Example) In case of "A" for KNH05 ;
L : 1.0±0.10mm, W : 0.5±0.20mm, T : 0.5mm max.

Size	Dimension Code	Dimension (mm)						Packaging φ 180 Reel				
		L	W	T	G	P	R	Code	Quantity	Taping Material	Taping Width	Cavity Pitch
KNH05	A	1.0 ± 0.10	0.5 ± 0.20	0.5max.	0.3 ± 0.10	0.15 ± 0.10	≥ 0.05	H	10,000	Paper	8mm	2mm
	B	1.0 ± 0.15	0.5 ± 0.15	0.5 ± 0.15	0.3 ± 0.10	0.15 ± 0.10	≥ 0.05	H	10,000	Paper	8mm	2mm
	C	1.0 ± 0.20	0.5 ± 0.20	0.5 ± 0.20	0.3 ± 0.10	0.15 ± 0.10	≥ 0.05	H	10,000	Paper	8mm	2mm

■ Dimension

(Unit: mm)

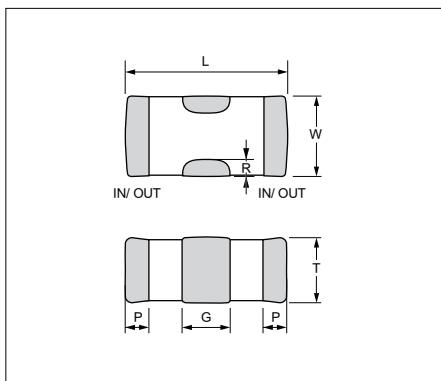

■ Recommended Land Pattern

(Unit: mm)

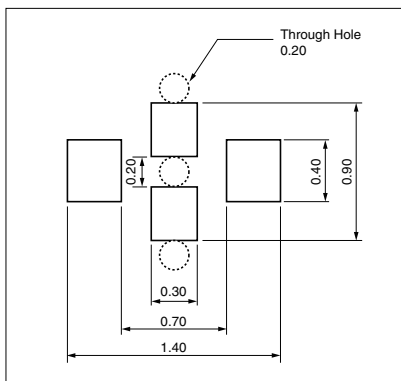



Test Conditions and Standards

Test Conditions and Specifications for Temperature Compensation Type (C Δ Characteristics) CM / CU Series

Test Items		Test Conditions	Specifications								
Capacitance Value (C)			Within tolerance								
Q		<table border="1"> <thead> <tr> <th>Capacitance</th> <th>Frequency</th> <th>Volt</th> </tr> </thead> <tbody> <tr> <td>C≤1000pF</td> <td>1MHz ± 10%</td> <td rowspan="2">0.5 to 5Vrms</td> </tr> <tr> <td>C>1000pF</td> <td>1kHz ± 10%</td> </tr> </tbody> </table>	Capacitance	Frequency	Volt	C≤1000pF	1MHz ± 10%	0.5 to 5Vrms	C>1000pF	1kHz ± 10%	C≥30pF : Q≥1000 C<30pF : Q≥400+20C
	Capacitance	Frequency	Volt								
C≤1000pF	1MHz ± 10%	0.5 to 5Vrms									
C>1000pF	1kHz ± 10%										
Insulation Resistance (IR)		Measured after the rated voltage is applied for 1 minute at room ambient. The charge and discharge current of the capacitor must not exceed 50mA.	Over 10000MΩ or 500MΩ · μF, whichever is less								
Dielectric Resistance		Apply 3 times of the rated voltage for 1 to 5 seconds. The charge and discharge current of the capacitor must not exceed 50mA.	No problem observed								
Appearance		Microscope	No problem observed								
Termination Strength		Apply a sideward force of 500g (5N) to a PCB-mounted sample. Apply 2N for 0201, and 1N for 01005 size.	No problem observed								
Bending Strength		Glass epoxy PCB: Fulcrum spacing: 90mm, duration time 10 seconds.	No significant damage at 1mm bent								
Vibration Test	Appearance	Vibration frequency: 10 to 55 (Hz) Amplitude: 1.5mm Sweeping condition: 10 → 55 → 10Hz/ 1 minute in X, Y and Z Directions: 2 hours each, 6 hours total.	No problem observed								
	Δ C		Within Tolerance								
	Q		C≥30pF : Q≥1000 C<30pF : Q≥400+20C								
Soldering Heat Resistance	Appearance	Soak the sample in 260°C ± 5°C solder for 10 ± 0.5 seconds and place in room ambient, and measure after 24 ± 2 hours. (Pre-heating conditions)	No problem observed								
	Δ C		Within ± 2.5% or ± 0.25pF, whichever is larger								
	Q		C≥30pF : Q≥1000 C<30pF : Q≥400+20C								
	IR		Over 10000MΩ or 500MΩ · μF whichever is less								
	Withstanding Voltage		<table border="1"> <thead> <tr> <th>Order</th> <th>Temperature</th> <th>Time</th> </tr> </thead> <tbody> <tr> <td>1</td> <td>80 to 100°C</td> <td>2 minutes</td> </tr> <tr> <td>2</td> <td>150 to 200°C</td> <td>2 minutes</td> </tr> </tbody> </table> The charge and discharge current of the capacitor must not exceed 50mA for IR and withstanding voltage measurement.	Order	Temperature	Time	1	80 to 100°C	2 minutes	2	150 to 200°C
Order	Temperature	Time									
1	80 to 100°C	2 minutes									
2	150 to 200°C	2 minutes									
Solderability		Soaking condition	Solder coverage : 90% min.								
Temperature Cycle	Appearance	(Cycle)	No problem observed								
	Δ C	Room temperature (3min.) →	Within ± 2.5% or ± 0.25pF, whichever is larger								
	Q	Lowest operation temperature (30min.) → Room temperature (3min.) →	C≥30pF : Q≥1000 C<30pF : Q≥400+20C								
	IR	Highest operation temperature(30min.)	Over 10000MΩ or 500MΩ · μF, whichever is less								
	Withstanding Voltage	After 5 cycles, measure after 24 ± 2 hours. The charge and discharge current of the capacitor must not exceed 50mA for IR and withstanding voltage measurement.	Resist without problem								
Load Humidity Test	Appearance	After applying rated voltage for 500+12/ - 0 hours in pre-condition at 40°C ± 2°C , humidity 90 to 95%RH, allow parts to stabilize for 24 ± 2 hours, at room temperature before measurement. The charge and discharge current of the capacitor must not exceed 50mA for IR measurement.	No problem observed								
	Δ C		Within ± 7.5% or ± 0.75pF, whichever is larger								
	Q		C≥30pF : Q≥200 C<30pF : Q≥100+10C/ 3								
	IR		Over 500MΩ or 25MΩ · μF, whichever is less								
High-Temperature with Loading	Appearance	After applying twice the rated voltage at the temperature of 125 ± 3°C for 1000+12/ - 0 hours, measure the sample after 24 ± 2 hours. The charge and discharge current of the capacitor must not exceed 50mA for IR measurement.	No problem observed.								
	Δ C		Within ± 3% or ± 0.3pF, whichever is larger								
	Q		C≥30pF : Q≥350 10pF<C<30pF : Q≥275+5C/ 2 C<10pF : Q≥200+10C								
	IR		Over 1000MΩ or 50MΩ · μF, whichever is less								

Please ask for individual specification for the hatched range in previous chart.



Test Conditions and Standards

Test Conditions and Specifications for High Dielectric Type (X5R, X7R) CM / CT Series

Test Items		Test Conditions	Specifications									
Capacitance Value (C)		Measure after heat treatment	Within tolerance									
Tan δ		<table border="1"> <thead> <tr> <th>Capacitance</th> <th>Frequency</th> <th>Volt</th> </tr> </thead> <tbody> <tr> <td>C\leq10μF</td> <td>1kHz \pm 10%</td> <td>1.0 \pm 0.2Vrms</td> </tr> <tr> <td>C$>$10μF</td> <td>120Hz \pm 10%</td> <td>0.5 \pm 0.2Vrms</td> </tr> </tbody> </table>	Capacitance	Frequency	Volt	C \leq 10 μ F	1kHz \pm 10%	1.0 \pm 0.2Vrms	C $>$ 10 μ F	120Hz \pm 10%	0.5 \pm 0.2Vrms	Refer to capacitance chart
Capacitance	Frequency	Volt										
C \leq 10 μ F	1kHz \pm 10%	1.0 \pm 0.2Vrms										
C $>$ 10 μ F	120Hz \pm 10%	0.5 \pm 0.2Vrms										
Insulation Resistance (IR)		Measured after the rated voltage is applied for 1 minute at room ambient. The charge and discharge current of the capacitor must not exceed 50mA.	Over 10000M Ω or 500M Ω · μ F, whichever is less									
Dielectric Resistance		Apply 2.5 times of the rated voltage for 1 to 5 seconds. The charge and discharge current of the capacitor must not exceed 50mA.	No problem observed									
Appearance		Microscope	No problem observed									
Termination Strength		Apply a sideward force of 500g (5N) to a PCB-mounted sample. note : 2N for 0201 size, and 1N for 01005 size. Exclude CT series with thickness of less than 0.66mm.	No problem observed									
Bending Strength		Glass epoxy PCB: Fulcrum spacing: 90mm, duration time 10 seconds. Exclude CT series with thickness of less than 0.66mm.	No significant damage at 1mm bent									
Vibration Test	Appearance	Take the initial value after heat treatment. Vibration frequency: 10 to 55 (Hz) Amplitude: 1.5mm Sweeping condition: 10 \rightarrow 55 \rightarrow 10Hz/ 1 minute in X, Y and Z Directions: 2 hours each, 6 hours total, and place in room ambient, and measure the sample after heat treatment.	No problem observed									
	Δ C		Within tolerance									
	Tan δ		Within tolerance									
Soldering Heat Resistance	Appearance	Take the initial value after heat treatment. Soak the sample in 260 \pm 5 $^{\circ}$ C solder for 10 \pm 0.5 seconds and place in room ambient, and measure after heat treatment. (Pre-heating conditions)	No problem observed									
	Δ C		Within \pm 7.5%									
	Tan δ		Within tolerance									
	IR		Over 10000M Ω or 500M Ω · μ F, whichever is less									
	Withstanding Voltage		Resist without problem									
Solderability		Soaking condition	Solder coverage : 90% min.									
		<table border="1"> <thead> <tr> <th>Order</th> <th>Temperature</th> <th>Time</th> </tr> </thead> <tbody> <tr> <td>1</td> <td>80 to 100$^{\circ}$C</td> <td>2 minutes</td> </tr> <tr> <td>2</td> <td>150 to 200$^{\circ}$C</td> <td>2 minutes</td> </tr> </tbody> </table>		Order	Temperature	Time	1	80 to 100 $^{\circ}$ C	2 minutes	2	150 to 200 $^{\circ}$ C	2 minutes
Order	Temperature	Time										
1	80 to 100 $^{\circ}$ C	2 minutes										
2	150 to 200 $^{\circ}$ C	2 minutes										
Temperature Cycle	Appearance	Take the initial value after heat treatment. (Cycle) Room temperature (3min.) \rightarrow Lowest operation temperature (30min.) \rightarrow Room temperature (3min.) \rightarrow Highest operation temperature(30min.) After 5 cycles, measure after heat treatment. The charge and discharge current of the capacitor must not exceed 50mA for IR and withstanding voltage measurement.	No problem observed									
	Δ C		Within \pm 7.5%									
	Tan δ		Within tolerance									
	IR		Over 10000M Ω or 500M Ω · μ F, whichever is less									
	Withstanding Voltage		Resist without problem									
Load Humidity Test	Appearance	Take the initial value after heat treatment. After applying rated voltage for 500+12/ - 0 hours in pre-condition at 40 $^{\circ}$ C \pm 2 $^{\circ}$ C , humidity 90 to 95%RH, and place in room ambient, and measure the sample after heat treatment. The charge and discharge current of the capacitor must not exceed 50mA for IR measurement.	No problem observed									
	Δ C		Within \pm 12.5%									
	Tan δ		200% max. of initial value									
	IR		Over 500M Ω or 25M Ω · μ F, whichever is less									
High-Temperature with Loading	Appearance	Take the initial value after heat treatment. After applying twice the rated voltage at the highest operation temperature for 1000+12/ - 0 hours, measure the sample after heat treatment. The charge and discharge current of the capacitor must not exceed 50mA for IR measurement. Apply 1.5 times when the rated voltage is 10V or less. Applied voltages for respective products are indicated in the below chart.	No problem observed									
	Δ C		Within \pm 12.5%									
	Tan δ		200% max. of initial value									
	IR		Over 1000M Ω or 50M Ω · μ F, whichever is less									

Heat treatment Keep specimen at 150+0/ - 10 $^{\circ}$ C for 1 hour, leave specimen at room ambient for 24 \pm 2 hours.

High-temperature with Loading Applied Voltage (Rated Voltage \times)

Applied Voltage	Rated Voltage	Products
\times 1.3	6.3V	CM02X5R153-104, CM105X5R475, CT03X5R104
\times 1.5	16V	CM02X5R101-103, CM05X5R224, CM105X5R225, CM21X5R475-106, CM316X5R226, CM02X7R101-222, CM105X7R105, CM316X7R106, CM32X7R226, CT105X5R105, CT21X5R475
	25V	CM03X5R332-103, CM105X5R105, CM21X5R225-475, CM316X5R106, CM32X5R106-226, CM05X7R104, CM21X7R105-225, CM316X7R475, CM32X7R106
	50V	CM21X5R105, CM32X5R106, CM32X7R106, CT21X5R225

Please ask for individual specification for the hatched range in previous chart.



Test Conditions and Standards

Substrate for Adhesion Strength Test, Vibration Test, Soldering Heat Resistance Test, Temperature Cycle Test, Load Humidity Test, High-Temperature with Loading Test.

(Unit: mm)

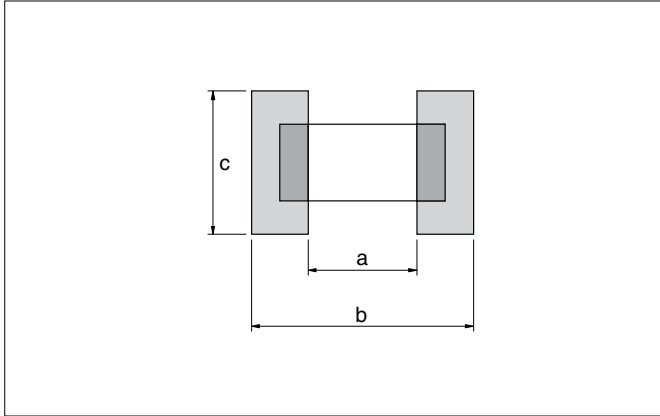

Size (EIA Code)	a	b	c
02 (01005)	0.15	0.50	0.20
03 (0201)	0.26	0.92	0.32
05 (0402)	0.4	1.4	0.5
105 (0603)	1.0	3.0	1.2
21 (0805)	1.2	4.0	1.65
316 (1206)	2.2	5.0	2.0
32 (1210)	2.2	5.0	2.9

Substrate for Bending Test

(Unit: mm)

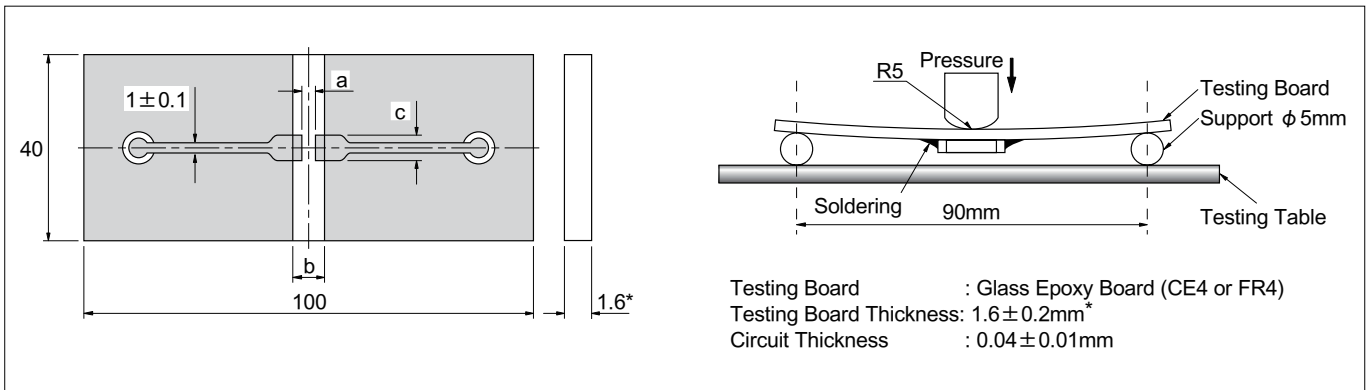

*02, 03, 05 size $0.8 \pm 0.1\text{mm}$

Structure

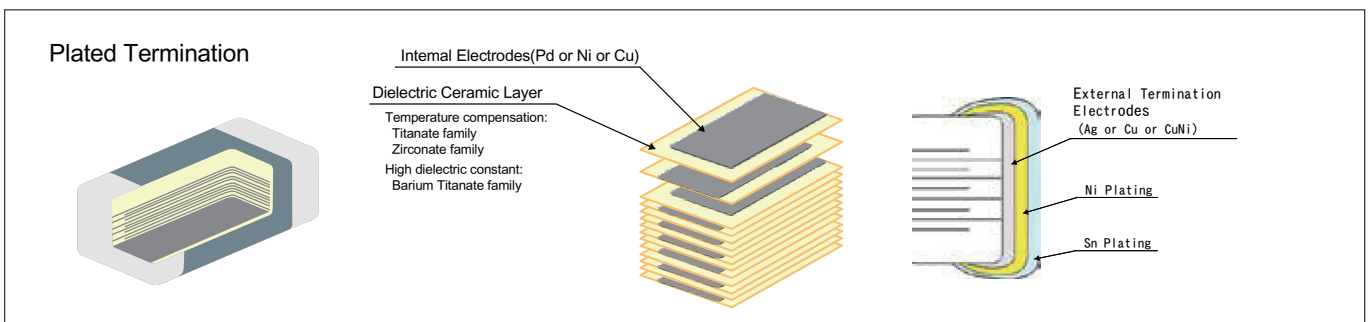

- Please contact your local Kyocera sales office or distributor for specifications not covered in this catalog.
- Our products are continually being improved. As a result, the capacitance range of each series is subject to change without notice. Please contact sales representative to confirm compatibility with your application.



Packaging Options Tape and Reel

Reel

(Unit: mm)

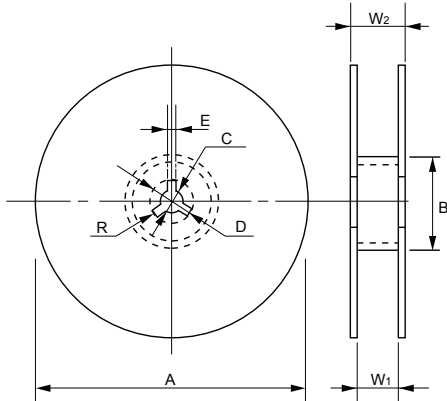

Code Reel	A	B	C	D
7-inch Reel (CODE: T, H, Q)	180 $^{+0}_{-2.0}$	φ 60 min.	13±0.5	21±0.8
7-inch Reel (CODE: P)	178±2.0			
13-inch Reel (CODE: L, N, W)	330±2.0			
Code Reel	E	W ₁	W ₂	R
7-inch Reel (CODE: T, H, Q)	2.0±0.5	10.5±1.5	16.5 max.	1.0
7-inch Reel (CODE: P)		4.35±0.3	6.95±1.0	
13-inch Reel (CODE: L, N, W)		9.5±1.0	16.5 max.	

Carrier Tape

F=1mm (02 Size)

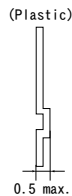
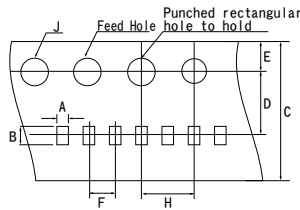

F=2mm (02, 03, 05 Size)

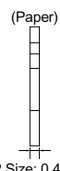
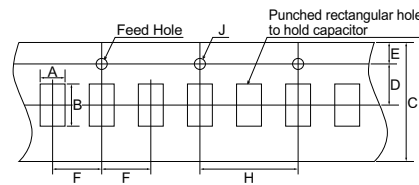

02 Size: 0.4 max.
03 Size: 0.6 max.
05 Size: 0.75 max.

F=1mm (02, 03, 05 Size)

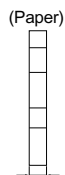
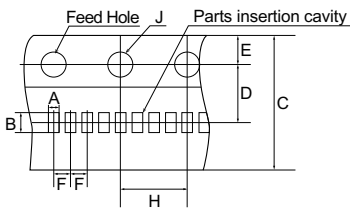

02 Size: 0.4 max.
03 Size: 0.5 max.
05 Size: 0.75 max.

F=4mm (105, 21, 316, 32 Size)

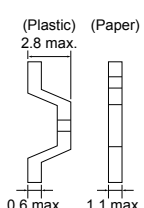
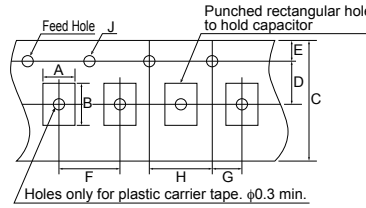

(Plastic) 2.8 max.
(Paper) 1.1 max.

Carrier Tape

(Unit: mm)

Size (EIA Code)	A	B	C	D	E	F	G	H	J	Carrier Tape	
										Width	Material
02 (01005)*	0.23±0.02	0.43±0.02	4.0±0.08	1.8±0.02	0.9±0.05	1.0±0.02	—	2.0±0.04	0.8±0.04	4mm	Plastic
	0.25±0.03	0.45±0.03	8.0±0.3	3.5±0.05	1.75±0.1	2.0±0.05		4.0±0.1	1.5+0.1/-0	8mm	Paper
03 (0201)*	0.37±0.03	0.67±0.03	8.0+0.3/-0.1	3.5±0.05	1.75±0.1	1.0±0.05	—	4.0±0.05	1.5+0.1/-0	8mm	Paper
			8.0±0.3			2.0±0.05		4.0±0.1			
05 (0402)*	0.65±0.1	1.15±0.1	8.0+0.3/-0.1	3.5±0.05	1.75±0.1	1.0±0.05	—	4.0±0.05	1.5+0.1/-0	8mm	Paper
	0.75±0.1		8.0±0.3			2.0±0.05		4.0±0.1			
105 (0603)	1.0±0.2	1.8±0.2	8.0±0.3	3.5±0.05	1.75±0.1	4.0±0.1	2.0±0.05	4.0±0.1	1.5+0.1/-0	8mm	Paper
										8mm	Plastic
21 (0805)	1.5±0.2	2.3±0.2	8.0±0.3	3.5±0.05	1.75±0.1	4.0±0.1	2.0±0.05	4.0±0.1	1.5+0.1/-0	8mm	Paper
										8mm	Plastic
316 (1206)	2.0±0.2	3.6±0.2	8.0±0.3	3.5±0.05	1.75±0.1	4.0±0.1	2.0±0.05	4.0±0.1	1.5+0.1/-0	8mm	Paper
										8mm	Plastic
32 (1210)	2.9±0.2	3.6±0.2	8.0±0.3	3.5±0.05	1.75±0.1	4.0±0.1	2.0±0.05	4.0±0.1	1.5+0.1/-0	8mm	Plastic

* Option



Packaging Options

Detail of leader and trailer

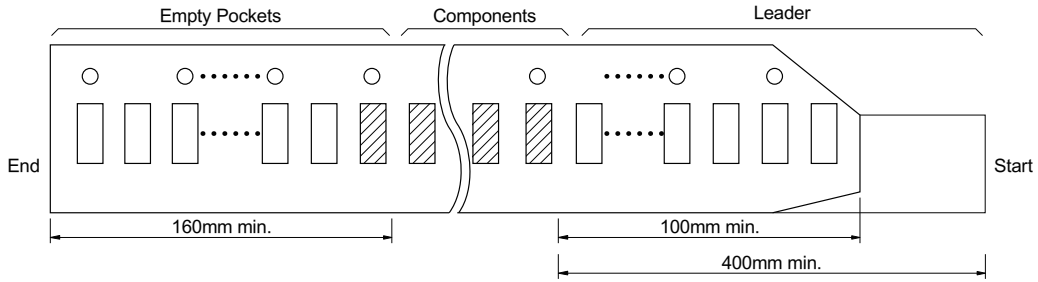

Adhesive tape

- 1) The exfoliative strength when peeling off the top tape from the carrier tape by the method of the following figure shall be ~ 0.1 to $0.7N$.
 $\varnothing 02$ Size: 0.1 to 0.5N
- 2) When the top tape is peeled off, the adhesive stays on the top tape.
- 3) Chip capacitors will be in a state free without being stuck on the thermal adhesive tape.

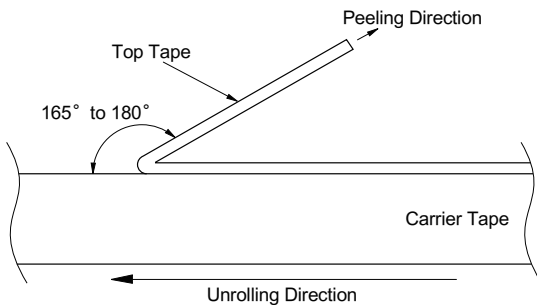

Exfoliating angle: 165 to 180 degrees to the carrier tape.
 Exfoliating speed: 300 mm/min.

Carrier tape

- 1) Chip will not fall off from carrier tape or carrier tape will not be damaged by bending than within a radius of 25mm.
- 2) The chip are inserted continuously without any empty pocket.
- 3) Chip will not be mis-mounted because of too big clearance between components and cavity. Also the waste of carrier tape will not fill a nozzle hole of mounting machine.



Surface Mounting Information

Dimensions for recommended typical land

Since the amount of solder (size of fillet) to be used has direct influence on the capacitor after mounting, the sufficient consideration is necessary.

When the amounts of solder is too much, the stress that a capacitor receives becomes larger. It may become the cause of a crack in the capacitor. When the land design of printed wiring board is considered, it is necessary to set up the form and size of land pattern so that the amount of solder is suitable.

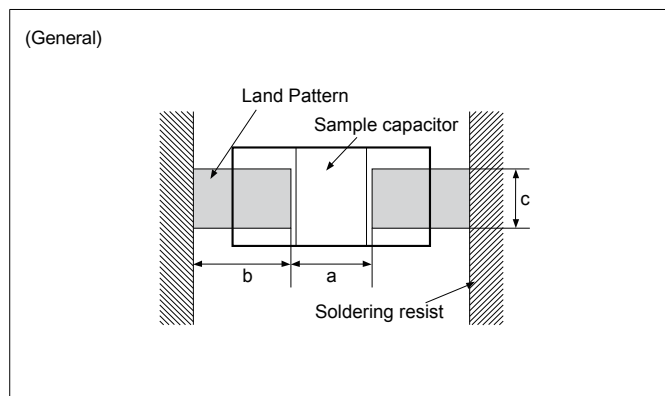

General

(Unit: mm)

Size (EIA Code)	Dimension		Recommended land dimensions		
	L	W / T	a	b	c
02 (01005)	0.4 ± 0.02	0.2 ± 0.02	0.13 to 0.20	0.12 to 0.18	0.20 to 0.23
	0.6 ± 0.03	0.3 ± 0.03	0.20 to 0.25	0.25 to 0.35	0.30 to 0.40
03 (0201)	0.6 ± 0.05	0.3 ± 0.05	0.23 to 0.30	0.25 to 0.35	0.30 to 0.45
	0.6 ± 0.09	0.3 ± 0.09	0.23 to 0.30	0.25 to 0.35	0.30 to 0.45
	0.6 ± 0.10	0.3 ± 0.10	0.23 to 0.30	0.25 to 0.35	0.30 to 0.45
	1.0 ± 0.05	0.5 ± 0.05	0.30 to 0.50	0.35 to 0.45	0.40 to 0.60
05 (0402)	1.0 ± 0.07	0.5 ± 0.07	0.30 to 0.50	0.40 to 0.50	0.50 to 0.75
	1.0 ± 0.10	0.5 ± 0.10	0.30 to 0.50	0.40 to 0.50	0.50 to 0.75
	1.0 ± 0.10	0.5 ± 0.20	0.30 to 0.50	0.40 to 0.50	0.50 to 0.75
	1.0 ± 0.15	0.5 ± 0.15	0.40 to 0.60	0.40 to 0.50	0.50 to 0.75
	1.0 ± 0.20	0.5 ± 0.20	0.40 to 0.60	0.40 to 0.50	0.50 to 0.75
	1.6 ± 0.10	0.8 ± 0.10	0.70 to 1.00	0.80 to 1.00	0.60 to 0.90
105 (0603)	1.6 ± 0.15	0.8 ± 0.15	0.80 to 1.00	0.80 to 1.00	0.80 to 1.10
	1.6 ± 0.20	0.8 ± 0.20	0.80 to 1.00	0.80 to 1.00	0.80 to 1.10
	2.0 ± 0.10	1.25 ± 0.10	1.00 to 1.30	1.00 to 1.20	1.00 to 1.45
21 (0805)	2.0 ± 0.15	1.25 ± 0.15	1.00 to 1.30	1.00 to 1.20	1.25 to 1.55
	2.0 ± 0.20	1.25 ± 0.20	1.00 to 1.30	1.00 to 1.20	1.25 to 1.55
	3.2 ± 0.20	1.6 ± 0.15	2.10 to 2.50	1.10 to 1.30	1.40 to 1.90
316 (1206)	3.2 ± 0.20	1.6 ± 0.20	2.10 to 2.50	1.10 to 1.30	1.60 to 2.00
	3.2 ± 0.30	1.6 ± 0.30	2.10 to 2.50	1.10 to 1.30	1.60 to 2.00
	3.2 ± 0.30	2.5 ± 0.20	2.10 to 2.50	1.10 to 1.30	1.90 to 2.80

* Recommended land dimensions may differ depending on dimensional tolerance.

Design of printed circuit and Soldering

The recommended fillet height shall be 1/2 of the thickness of capacitors or 0.5mm. When mounting two or more capacitors in the common land, it is necessary to separate the land with the solder resist strike so that it may become the exclusive land of each capacitor.

Ideal Solder Height

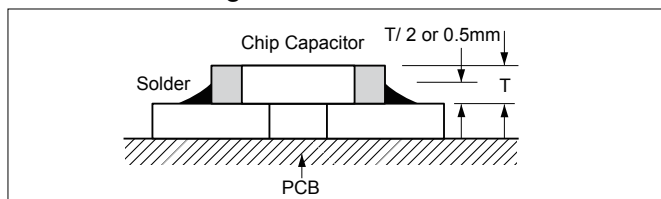

Item	Not recommended example	Recommended example/ Separated by solder
Multiple parts mount		
Mount with leaded parts		
Wire soldering after mounting		
Overview		



Surface Mounting Information

Mounting Design

The chip could crack if the PCB warps during processing after the chip has been soldered.

Recommended chip position on PCB to minimize stress from PCB warpage



Actual Mounting

- 1) If the position of the vacuum nozzle is too low, a large force may be applied to the chip capacitor during mounting, resulting in cracking.
- 2) During mounting, set the nozzle pressure to a static load of 1 to 3 N.
- 3) To minimize the shock of the vacuum nozzle, provide a support pin on the back of the PCB to minimize PCB flexure.

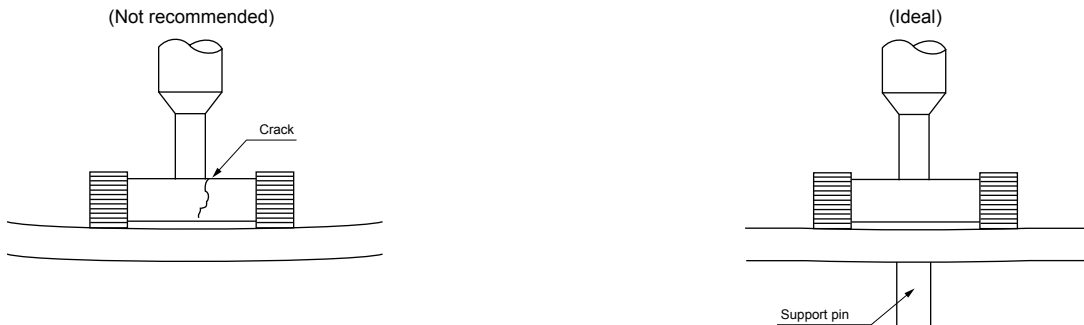

- 4) Bottom position of pick up nozzle should be adjusted to the top surface of a substrate which camber is corrected.

Resin Mold

- 1) If a large amount of resin is used for molding the chip, cracks may occur due to contraction stress during curing. To avoid such cracks, use a low shrinkage resin.
- 2) The insulation resistance of the chip will degrade due to moisture absorption. Use a low moisture absorption resin.
- 3) Check carefully that the resin does not generate a decomposition gas or reaction gas during the curing process or during normal storage. Such gases may crack the chip capacitor or damage the device itself.



Surface Mounting Information

Soldering Method

- 1) Ceramic is easily damaged by rapid heating or cooling. If some heat shock is unavoidable, preheat enough to limit the temperature difference (Delta T) to within 150 degree Celsius.
- 2) The product size 1.6 × 0.8mm to 3.2 × 1.6mm can be used in reflow and wave soldering, and the product size of bigger than 3.2 × 1.6mm, or smaller than 1.6 × 0.8mm can be used in reflow.
Circuit shortage and smoking can be created by using capacitors which are used neglecting the above caution.
- 3) Please see our recommended soldering conditions.
- 4) In case of using Sn-Zn Solder, please contact us in advance.
- 5) The following condition is recommended for spot heater application.

• Recommended spot heater condition

Item	Condition
Distance	5mm min.
Angle	45°
Projection Temp.	400°C max.
Flow rate	Set at the minimum
Nozzle diameter	2 φ to 4 φ (Single hole type)
Application time	10 sec. max. (1206 and smaller) 30 sec. max. (1210 and larger)

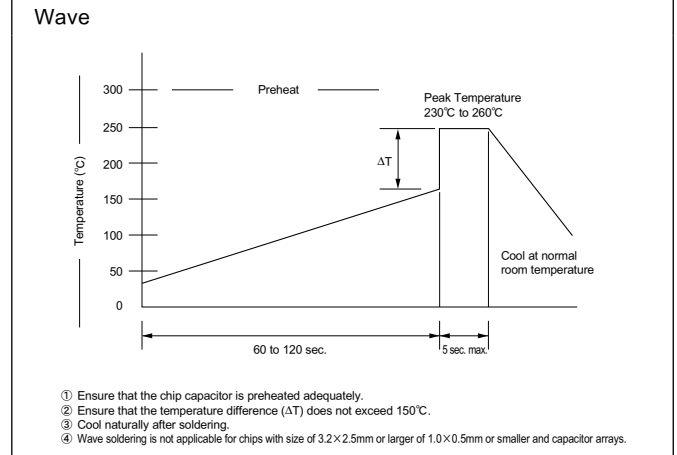
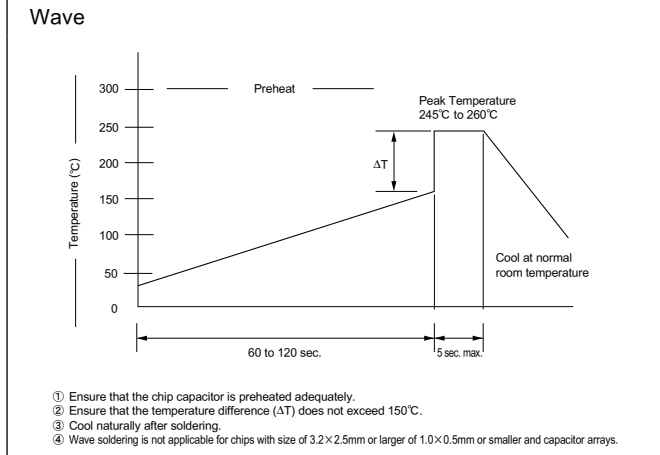
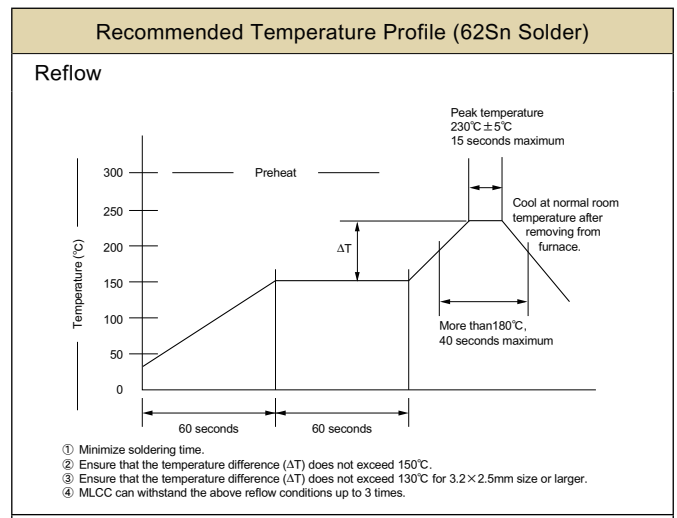
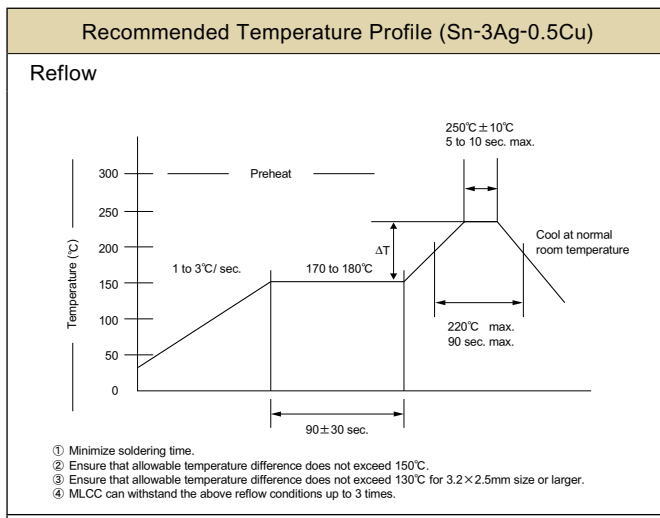
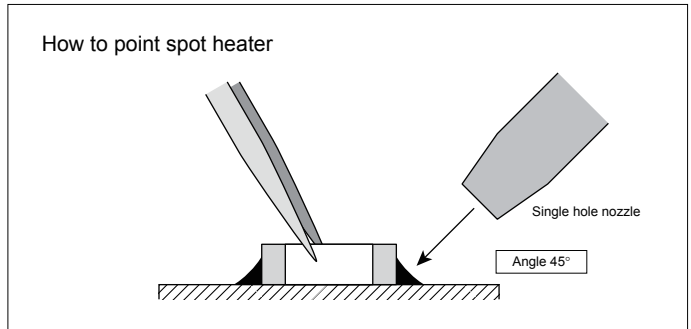

Soldering iron

- | | | |
|--------------------------------|-----------------------------|--|
| 1) Temperature of iron chip | 1206 and smaller 350°C max. | 5) Cautions |
| | 1210 and larger 280°C max. | a) Pre-heating is necessary rapid heating must be avoided.
Delta T ≤ 150°C (product size of bigger than 3.2 × 1.6mm. Delta T ≤ 130°C) |
| 2) Wattage | 80W max. | b) Avoid direct touching to capacitors. |
| 3) Tip shape of soldering iron | φ 3.0mm max. | c) Avoid rapid cooling after soldering. Natural cooling is recommended. |
| 4) Soldering Time | 3 sec. max. | |

*Consult as if it is difficult to keep the temperature 280°C max. for 1210 and larger MLCC'S.



Precautions

Circuit Design

1. Once application and assembly environments have been checked, the capacitor may be used in conformance with the rating and performance which are provided in both the catalog and the specifications. Use exceeding that which is specified may result in inferior performance or cause a short, open, smoking, or flaming to occur, etc.
2. Please consult the manufacturer in advance when the capacitor is used in devices such as: devices which deal with human life, i.e. medical devices; devices which are highly public orientated; and devices which demand a high standard of liability. Accident or malfunction of devices such as medical devices, space equipment and devices having to do with atomic power could generate grave consequence with respect to human lives or, possibly, a portion of the public. Capacitors used in these devices may require high reliability design different from that of general purpose capacitors.
3. Please use the capacitors in conformance with the operating temperature provided in both the catalog and the specifications. Be especially cautious not to exceed the maximum temperature. In the situation the maximum temperature set forth in both the catalog and specifications is exceeded, the capacitor's insulation resistance may deteriorate, power may suddenly surge and short-circuit may occur. The capacitor has a loss, and may self-heat due to equivalent series resistance when alternating electric current is passed therethrough. As this effect becomes especially pronounced in high frequency circuits, please exercise caution. When using the capacitor in a (self-heating) circuit, please make sure the surface of the capacitor remains under the maximum temperature for usage. Also, please make certain temperature rises remain below 20°C .
4. Please keep voltage under the rated voltage which is applied to the capacitor. Also, please make certain the peak voltage remains below the rated voltage when AC voltage is super-imposed to the DC voltage. In the situation where AC or pulse voltage is employed, ensure average peak voltage does not exceed the rated voltage. Exceeding the rated voltage provided in both catalog and specifications may lead to defective withstanding voltage or, in worst case situations, may cause the capacitor to smoke or flame.
5. When the capacitor is to be employed in a circuit in which there is continuous application of a high frequency voltage or a steep pulse voltage, even though it is within the rated voltage, please inquire to the manufacturer. In the situation the capacitor is to be employed using a high frequency AC voltage or a extremely fast rising pulse voltage, even though it is within the rated voltage, it is possible capacitor reliability will deteriorate.
6. It is a common phenomenon of high-dielectric products to have a deteriorated amount of static electricity due to the application of DC voltage. Due caution is necessary as the degree of deterioration varies depending on the quality of capacitor materials, capacity, as well as the load voltage at the time of operation.
7. Do not use the capacitor in an environment where it might easily exceed the respective provisions concerning shock and vibration specified in the catalog and specifications. In addition, it is a common piezo phenomenon of high dielectric products to have some voltage due to vibration or to have noise due to voltage change. Please contact sales in such case.
8. If the electrostatic capacity value of the delivered capacitor is within the specified tolerance, please consider this when designing the respective product in order that the assembled product function appropriately.
9. Please contact us upon using conductive adhesives.

Storage

1. If the component is stored in minimal packaging (a heat-sealed or zippered plastic bag), the bag should be kept closed. Once the bag has been opened, reseal it or store it in a desiccator.
2. Keep storage place temperature + 5 to + 40 degree C, humidity 20 to 70% RH. See JIS C 60721-3-1, class 1K2 for other climatic conditions.
3. The storage atmosphere must be free of corrosive gas such as sulfur dioxide and chlorine. Also, avoid exposing the product to saline moisture. If the product is exposed to such atmospheres, the terminals will oxidize and solderability will be effected.
4. Precautions 1) to 3) apply to chip capacitors packaged in carrier tapes.
5. The solderability is assured for 6 months from our shipping date if the above storage precautions are followed.

Safety application guideline and detailed information of electrical properties are also provided in Kyocera web site;
URL: <https://global.kyocera.com/prdct/electro/>



Part Number List



General CM02 Series Size (JIS Code): 01005(0402) # Packaging Code (Packaging quantity): H(20,000pcs.) / N(80,000pcs.) / P(40,000pcs.)

Dielectric code CΔ	Capacitance	□:Tolerance	Voltage [V]	Part Number	Q	Dimension			# Packaging Code (quantity)
						L[mm]	W[mm]	T[mm]	
CG/CH	1pF	B: ± 0.1pF / C: ± 0.25pF	25	CM02C Δ 1R0 □ 25A#	420	0.4 ± 0.02	0.2 ± 0.02	0.2 ± 0.02	H / N / P
	1.5pF			CM02C Δ 1R5 □ 25A#	430	0.4 ± 0.02	0.2 ± 0.02	0.2 ± 0.02	H / N / P
	2pF			CM02C Δ 2R0 □ 25A#	440	0.4 ± 0.02	0.2 ± 0.02	0.2 ± 0.02	H / N / P
	3pF			CM02C Δ 3R0 □ 25A#	460	0.4 ± 0.02	0.2 ± 0.02	0.2 ± 0.02	H / N / P
	4pF			CM02C Δ 4R0 □ 25A#	480	0.4 ± 0.02	0.2 ± 0.02	0.2 ± 0.02	H / N / P
	5pF			CM02C Δ 5R0 □ 25A#	500	0.4 ± 0.02	0.2 ± 0.02	0.2 ± 0.02	H / N / P
	6pF	C: ± 0.25pF / D: ± 0.5pF	25	CM02C Δ 6R0 □ 25A#	520	0.4 ± 0.02	0.2 ± 0.02	0.2 ± 0.02	H / N / P
	7pF			CM02C Δ 7R0 □ 25A#	540	0.4 ± 0.02	0.2 ± 0.02	0.2 ± 0.02	H / N / P
	8pF			CM02C Δ 8R0 □ 25A#	560	0.4 ± 0.02	0.2 ± 0.02	0.2 ± 0.02	H / N / P
	9pF			CM02C Δ 9R0 □ 25A#	580	0.4 ± 0.02	0.2 ± 0.02	0.2 ± 0.02	H / N / P
	10pF			CM02C Δ 100 □ 25A#	600	0.4 ± 0.02	0.2 ± 0.02	0.2 ± 0.02	H / N / P
	12pF			CM02C Δ 120 □ 25A#	640	0.4 ± 0.02	0.2 ± 0.02	0.2 ± 0.02	H / N / P
	15pF	J: ± 5% / K: ± 10%	25	CM02C Δ 150 □ 25A#	700	0.4 ± 0.02	0.2 ± 0.02	0.2 ± 0.02	H / N / P
	18pF			CM02C Δ 180 □ 25A#	760	0.4 ± 0.02	0.2 ± 0.02	0.2 ± 0.02	H / N / P
	22pF			CM02C Δ 220 □ 25A#	840	0.4 ± 0.02	0.2 ± 0.02	0.2 ± 0.02	H / N / P
	27pF			CM02C Δ 270 □ 16A#	940	0.4 ± 0.02	0.2 ± 0.02	0.2 ± 0.02	H / N / P
	33pF			CM02C Δ 330 □ 16A#	1000	0.4 ± 0.02	0.2 ± 0.02	0.2 ± 0.02	H / N / P
	39pF			CM02C Δ 390 □ 16A#	1000	0.4 ± 0.02	0.2 ± 0.02	0.2 ± 0.02	H / N / P
	47pF	J: ± 5% / K: ± 10%	16	CM02C Δ 470 □ 16A#	1000	0.4 ± 0.02	0.2 ± 0.02	0.2 ± 0.02	H / N / P
	56pF			CM02C Δ 560 □ 16A#	1000	0.4 ± 0.02	0.2 ± 0.02	0.2 ± 0.02	H / N / P
	68pF			CM02C Δ 680 □ 16A#	1000	0.4 ± 0.02	0.2 ± 0.02	0.2 ± 0.02	H / N / P
	82pF			CM02C Δ 820 □ 16A#	1000	0.4 ± 0.02	0.2 ± 0.02	0.2 ± 0.02	H / N / P
100pF	CM02C Δ 101 □ 16A#			1000	0.4 ± 0.02	0.2 ± 0.02	0.2 ± 0.02	H / N / P	
120pF	CM02C Δ 121 □ 16A#			1000	0.4 ± 0.02	0.2 ± 0.02	0.2 ± 0.02	H / N / P	
150pF	CM02C Δ 151 □ 16A#			1000	0.4 ± 0.02	0.2 ± 0.02	0.2 ± 0.02	H / N / P	
180pF	CM02C Δ 181 □ 16A#			1000	0.4 ± 0.02	0.2 ± 0.02	0.2 ± 0.02	H / N / P	
220pF	CM02C Δ 221 □ 16A#			1000	0.4 ± 0.02	0.2 ± 0.02	0.2 ± 0.02	H / N / P	

General CM03 Series Size (JIS Code) : 0201(0603) # Packaging Code (Packaging quantity) : H(15,000pcs.) / N(50,000pcs.) / Q(30,000pcs.) / W(150,000pcs.)

Dielectric code CΔ	Capacitance	□:Tolerance	Voltage [V]	Part Number	Q	Dimension			# Packaging Code (quantity)
						L[mm]	W[mm]	T[mm]	
CG/CH	1pF	B: ± 0.1pF / C: ± 0.25pF	50	CM03C Δ 1R0 □ 50A#	420	0.6 ± 0.03	0.3 ± 0.03	0.3 ± 0.03	H / N / Q / W
	1.5pF			CM03C Δ 1R5 □ 50A#	430	0.6 ± 0.03	0.3 ± 0.03	0.3 ± 0.03	H / N / Q / W
	2pF			CM03C Δ 2R0 □ 50A#	440	0.6 ± 0.03	0.3 ± 0.03	0.3 ± 0.03	H / N / Q / W
	3pF			CM03C Δ 3R0 □ 50A#	460	0.6 ± 0.03	0.3 ± 0.03	0.3 ± 0.03	H / N / Q / W
	4pF			CM03C Δ 4R0 □ 50A#	480	0.6 ± 0.03	0.3 ± 0.03	0.3 ± 0.03	H / N / Q / W
	5pF			CM03C Δ 5R0 □ 50A#	500	0.6 ± 0.03	0.3 ± 0.03	0.3 ± 0.03	H / N / Q / W
	6pF	C: ± 0.25pF / D: ± 0.5pF	50	CM03C Δ 6R0 □ 50A#	520	0.6 ± 0.03	0.3 ± 0.03	0.3 ± 0.03	H / N / Q / W
	7pF			CM03C Δ 7R0 □ 50A#	540	0.6 ± 0.03	0.3 ± 0.03	0.3 ± 0.03	H / N / Q / W
	8pF			CM03C Δ 8R0 □ 50A#	560	0.6 ± 0.03	0.3 ± 0.03	0.3 ± 0.03	H / N / Q / W
	9pF			CM03C Δ 9R0 □ 50A#	580	0.6 ± 0.03	0.3 ± 0.03	0.3 ± 0.03	H / N / Q / W
	10pF			CM03C Δ 100 □ 50A#	600	0.6 ± 0.03	0.3 ± 0.03	0.3 ± 0.03	H / N / Q / W
	12pF			CM03C Δ 120 □ 50A#	640	0.6 ± 0.03	0.3 ± 0.03	0.3 ± 0.03	H / N / Q / W
	15pF	J: ± 5% / K: ± 10%	50	CM03C Δ 150 □ 50A#	700	0.6 ± 0.03	0.3 ± 0.03	0.3 ± 0.03	H / N / Q / W
	18pF			CM03C Δ 180 □ 50A#	760	0.6 ± 0.03	0.3 ± 0.03	0.3 ± 0.03	H / N / Q / W
	22pF			CM03C Δ 220 □ 50A#	840	0.6 ± 0.03	0.3 ± 0.03	0.3 ± 0.03	H / N / Q / W
	27pF			CM03C Δ 270 □ 50A#	940	0.6 ± 0.03	0.3 ± 0.03	0.3 ± 0.03	H / N / Q / W
	33pF			CM03C Δ 330 □ 50A#	1000	0.6 ± 0.03	0.3 ± 0.03	0.3 ± 0.03	H / N / Q / W
	39pF			CM03C Δ 390 □ 50A#	1000	0.6 ± 0.03	0.3 ± 0.03	0.3 ± 0.03	H / N / Q / W
	47pF	J: ± 5% / K: ± 10%	50	CM03C Δ 470 □ 50A#	1000	0.6 ± 0.03	0.3 ± 0.03	0.3 ± 0.03	H / N / Q / W
	56pF			CM03C Δ 560 □ 50A#	1000	0.6 ± 0.03	0.3 ± 0.03	0.3 ± 0.03	H / N / Q / W
	68pF			CM03C Δ 680 □ 50A#	1000	0.6 ± 0.03	0.3 ± 0.03	0.3 ± 0.03	H / N / Q / W
	82pF			CM03C Δ 820 □ 50A#	1000	0.6 ± 0.03	0.3 ± 0.03	0.3 ± 0.03	H / N / Q / W
100pF	CM03C Δ 101 □ 50A#			1000	0.6 ± 0.03	0.3 ± 0.03	0.3 ± 0.03	H / N / Q / W	



Part Number List



General CM02 Series Size (JIS Code) : 01005(0402) # Packaging Code (Packaging quantity) : H(20,000pcs.) / N(80,000pcs.) / P(40,000pcs.)

Dielectric code	Capacitance	□:Tolerance	Voltage [V]	Part Number	Tan δ [%]	Dimension			# Packaging Code (quantity)
						L[mm]	W[mm]	T[mm]	
X5R	100pF	K: ± 10% / M: ± 20%	16	CM02X5R101 □ 16A#	12.5	0.4 ± 0.02	0.2 ± 0.02	0.2 ± 0.02	H / N / P
	150pF			CM02X5R151 □ 16A#	12.5	0.4 ± 0.02	0.2 ± 0.02	0.2 ± 0.02	H / N / P
	220pF			CM02X5R221 □ 16A#	12.5	0.4 ± 0.02	0.2 ± 0.02	0.2 ± 0.02	H / N / P
	330pF			CM02X5R331 □ 16A#	12.5	0.4 ± 0.02	0.2 ± 0.02	0.2 ± 0.02	H / N / P
	470pF			CM02X5R471 □ 16A#	12.5	0.4 ± 0.02	0.2 ± 0.02	0.2 ± 0.02	H / N / P
	680pF			CM02X5R681 □ 16A#	12.5	0.4 ± 0.02	0.2 ± 0.02	0.2 ± 0.02	H / N / P
	1nF			CM02X5R102 □ 16A#	12.5	0.4 ± 0.02	0.2 ± 0.02	0.2 ± 0.02	H / N / P
	1.5nF			CM02X5R152 □ 16A#	12.5	0.4 ± 0.02	0.2 ± 0.02	0.2 ± 0.02	H / N / P
	2.2nF			CM02X5R222 □ 16A#	12.5	0.4 ± 0.02	0.2 ± 0.02	0.2 ± 0.02	H / N / P
	3.3nF			CM02X5R332 □ 16A#	12.5	0.4 ± 0.02	0.2 ± 0.02	0.2 ± 0.02	H / N / P
	4.7nF			CM02X5R472 □ 16A#	12.5	0.4 ± 0.02	0.2 ± 0.02	0.2 ± 0.02	H / N / P
	6.8nF			CM02X5R682 □ 16A#	12.5	0.4 ± 0.02	0.2 ± 0.02	0.2 ± 0.02	H / N / P
	10nF			CM02X5R103 □ 16A#	12.5	0.4 ± 0.02	0.2 ± 0.02	0.2 ± 0.02	H / N / P
	15nF			CM02X5R153 □ 06A#	12.5	0.4 ± 0.02	0.2 ± 0.02	0.2 ± 0.02	H / N / P
	22nF	CM02X5R223 □ 06A#	12.5	0.4 ± 0.02	0.2 ± 0.02	0.2 ± 0.02	H / N / P		
	33nF	CM02X5R333 □ 06A#	12.5	0.4 ± 0.02	0.2 ± 0.02	0.2 ± 0.02	H / N / P		
	47nF	CM02X5R473 □ 06A#	12.5	0.4 ± 0.02	0.2 ± 0.02	0.2 ± 0.02	H / N / P		
	68nF	CM02X5R683 □ 06A#	12.5	0.4 ± 0.02	0.2 ± 0.02	0.2 ± 0.02	H / N / P		
	100nF	K: ± 10% / M: ± 20%	10	CM02X5R104 □ 10A#	12.5	0.4 ± 0.02	0.2 ± 0.02	0.2 ± 0.02	H / N / P
	470nF	K: ± 10% / M: ± 20%	6.3	CM02X5R104 □ 06A#	12.5	0.4 ± 0.02	0.2 ± 0.02	0.2 ± 0.02	H / N / P
	220nF	M: ± 20%	6.3	CM02X5R224M06A#	12.5	0.4 ± 0.02	0.2 ± 0.02	0.2 ± 0.02	H / N / P
	470nF			CM02X5R474M06A#	12.5	0.4 ± 0.02	0.2 ± 0.02	0.2 ± 0.02	H / N / P
X7R	100pF	K: ± 10% / M: ± 20%	16	CM02X7R101 □ 16A#	12.5	0.4 ± 0.02	0.2 ± 0.02	0.2 ± 0.02	H / N / P
	150pF			CM02X7R151 □ 16A#	12.5	0.4 ± 0.02	0.2 ± 0.02	0.2 ± 0.02	H / N / P
	220pF			CM02X7R221 □ 16A#	12.5	0.4 ± 0.02	0.2 ± 0.02	0.2 ± 0.02	H / N / P
	330pF			CM02X7R331 □ 16A#	12.5	0.4 ± 0.02	0.2 ± 0.02	0.2 ± 0.02	H / N / P
	470pF			CM02X7R471 □ 16A#	12.5	0.4 ± 0.02	0.2 ± 0.02	0.2 ± 0.02	H / N / P
	680pF			CM02X7R681 □ 16A#	12.5	0.4 ± 0.02	0.2 ± 0.02	0.2 ± 0.02	H / N / P
	1nF			CM02X7R102 □ 16A#	12.5	0.4 ± 0.02	0.2 ± 0.02	0.2 ± 0.02	H / N / P
	1.5nF			CM02X7R152 □ 16A#	12.5	0.4 ± 0.02	0.2 ± 0.02	0.2 ± 0.02	H / N / P
	2.2nF			CM02X7R222 □ 16A#	12.5	0.4 ± 0.02	0.2 ± 0.02	0.2 ± 0.02	H / N / P

General CM03 Series Size (JIS Code) : 0201(0603) # Packaging Code (Packaging quantity) : H(15,000pcs.) / N(50,000pcs.) / Q(30,000pcs.) / W(150,000pcs.)

Dielectric code	Capacitance	□:Tolerance	Voltage [V]	Part Number	Tan δ [%]	Dimension			# Packaging Code (quantity)	
						L[mm]	W[mm]	T[mm]		
X5R	3.3nF	K: ± 10% / M: ± 20%	25	CM03X5R332 □ 25A#	5.0	0.6 ± 0.03	0.3 ± 0.03	0.3 ± 0.03	H / N / Q / W	
	4.7nF			CM03X5R472 □ 25A#	5.0	0.6 ± 0.03	0.3 ± 0.03	0.3 ± 0.03	H / N / Q / W	
	6.8nF			CM03X5R682 □ 25A#	5.0	0.6 ± 0.03	0.3 ± 0.03	0.3 ± 0.03	H / N / Q / W	
	10nF			CM03X5R103 □ 25A#	5.0	0.6 ± 0.03	0.3 ± 0.03	0.3 ± 0.03	H / N / Q / W	
	15nF			CM03X5R153 □ 10A#	10.0	0.6 ± 0.03	0.3 ± 0.03	0.3 ± 0.03	H / N / Q / W	
	22nF			CM03X5R223 □ 10A#	10.0	0.6 ± 0.03	0.3 ± 0.03	0.3 ± 0.03	H / N / Q / W	
	33nF	K: ± 10% / M: ± 20%	10	CM03X5R333 □ 10A#	10.0	0.6 ± 0.03	0.3 ± 0.03	0.3 ± 0.03	H / N / Q / W	
	47nF			CM03X5R473 □ 10A#	10.0	0.6 ± 0.03	0.3 ± 0.03	0.3 ± 0.03	H / N / Q / W	
	68nF			CM03X5R683 □ 10A#	10.0	0.6 ± 0.03	0.3 ± 0.03	0.3 ± 0.03	H / N / Q / W	
	100nF			CM03X5R104 □ 10A#	10.0	0.6 ± 0.03	0.3 ± 0.03	0.3 ± 0.03	H / N / Q / W	
	220nF			CM03X5R224 □ 10A#	10.0	0.6 ± 0.03	0.3 ± 0.03	0.3 ± 0.03	H / N / Q / W	
	470nF			CM03X5R474 □ 06A#	12.5	0.6 ± 0.03	0.3 ± 0.03	0.3 ± 0.03	H / N / Q / W	
	X5R	1μF	M: ± 20%	16	CM03X5R105M16AH	20.0	0.6 ± 0.09	0.3 ± 0.09	0.3 ± 0.09	H
				6.3	CM03X5R105M06A#	12.5	0.6 ± 0.05	0.3 ± 0.05	0.3 ± 0.05	H / N / Q / W
				10	CM03X5R225M10AH	15.0	0.6 ± 0.09	0.3 ± 0.09	0.3 ± 0.09	H
		2.2μF	M: ± 20%	6.3	CM03X5R225M06A#	12.5	0.6 ± 0.09	0.3 ± 0.09	0.3 ± 0.09	H
					CM03X5R225M06A#035	12.5	0.6 ± 0.05	0.3 ± 0.05	0.3 ± 0.05	H / N / Q / W
					CM03X5R475M04AH	12.5	0.6 ± 0.09	0.3 ± 0.09	0.3 ± 0.09	H
X7R	4.7μF	K: ± 10% / M: ± 20%	10	CM03X7R332 □ 10A#	5.0	0.6 ± 0.03	0.3 ± 0.03	0.3 ± 0.03	H / N / Q / W	
	3.3nF			CM03X7R472 □ 10A#	5.0	0.6 ± 0.03	0.3 ± 0.03	0.3 ± 0.03	H / N / Q / W	
	4.7nF			CM03X7R682 □ 10A#	5.0	0.6 ± 0.03	0.3 ± 0.03	0.3 ± 0.03	H / N / Q / W	
	6.8nF			CM03X7R103 □ 10A#	5.0	0.6 ± 0.03	0.3 ± 0.03	0.3 ± 0.03	H / N / Q / W	
	10nF			CM03X7R103 □ 10A#	5.0	0.6 ± 0.03	0.3 ± 0.03	0.3 ± 0.03	H / N / Q / W	

General CM05 Series Size (JIS Code) : 0402(1005) # Packaging Code (Packaging quantity) : H(10,000pcs.) / N(50,000pcs.) / Q(20,000pcs.) / W(100,000pcs.)

Dielectric code	Capacitance	□:Tolerance	Voltage [V]	Part Number	Tan δ [%]	Dimension			# Packaging Code (quantity)	
						L[mm]	W[mm]	T[mm]		
X5R	100nF	K: ± 10% / M: ± 20%	25	CM05X5R104 □ 25A#	5.0	1.0 ± 0.05	0.5 ± 0.05	0.5 ± 0.05	H / N / Q / W	
	220nF			CM05X5R224 □ 16A#	12.5	1.0 ± 0.05	0.5 ± 0.05	0.5 ± 0.05	H / N / Q / W	
	470nF			CM05X5R474 □ 10A#	12.5	1.0 ± 0.05	0.5 ± 0.05	0.5 ± 0.05	H / N / Q / W	
	1μF	K: ± 10% / M: ± 20%	10	35	CM05X5R105 □ 35A#	10.0	1.0 ± 0.05	0.5 ± 0.05	0.5 ± 0.05	H / N / Q / W
				25	CM05X5R105 □ 25A#	10.0	1.0 ± 0.05	0.5 ± 0.05	0.5 ± 0.05	H / N / Q / W
				16	CM05X5R105 □ 16A#	10.0	1.0 ± 0.05	0.5 ± 0.05	0.5 ± 0.05	H / N / Q / W
				10	CM05X5R105 □ 10A#	10.0	1.0 ± 0.05	0.5 ± 0.05	0.5 ± 0.05	H / N / Q / W
				16	CM05X5R225 □ 16A#	12.5	1.0 ± 0.05	0.5 ± 0.05	0.5 ± 0.05	H / N / Q / W
				10	CM05X5R225 □ 10A#	12.5	1.0 ± 0.05	0.5 ± 0.05	0.5 ± 0.05	H / N / Q / W
	2.2μF	K: ± 10% / M: ± 20%	10	25	CM05X5R475M25AH	12.5	1.0 ± 0.20	0.5 ± 0.20	0.5 ± 0.20	H
				16	CM05X5R475M16AH	12.5	1.0 ± 0.20	0.5 ± 0.20	0.5 ± 0.20	H
				10	CM05X5R475M10AH	12.5	1.0 ± 0.20	0.5 ± 0.20	0.5 ± 0.20	H
				6.3	CM05X5R106M06A#	12.5	1.0 ± 0.20	0.5 ± 0.20	0.5 ± 0.20	H
	4.7μF	M: ± 20%	6.3	4	CM05X5R156M04A#	12.5	1.0 ± 0.15	0.5 ± 0.15	0.5 ± 0.15	H / N
				4	CM05X5R156M04A#	12.5	1.0 ± 0.15	0.5 ± 0.15	0.5 ± 0.15	H / N
	15μF	M: ± 20%	4	CM05X5R226M04A#	12.5	1.0 ± 0.20	0.5 ± 0.20	0.5 ± 0.20	H	
	22μF	M: ± 20%	4	CM05X5R226M04A#	12.5	1.0 ± 0.20	0.5 ± 0.20	0.5 ± 0.20	H	
	X7R	100nF	K: ± 10% / M: ± 20%	25	CM05X7R104 □ 25A#	12.5	1.0 ± 0.05	0.5 ± 0.05	0.5 ± 0.05	H / N / Q / W



Part Number List



General CM105 Series Size (JIS Code) : 0603(1608) # Packaging Code (Packaging quantity) : T(4,000pcs.) / L(10,000pcs.)

Dielectric code	Capacitance	□:Tolerance	Voltage [V]	Part Number	Tan δ [%]	Dimension			# Packaging Code (quantity)
						L[mm]	W[mm]	T[mm]	
X5R	1μF	K: ± 10% / M: ± 20%	25	CM105X5R105 □ 25A#	12.5	1.6 ± 0.15	0.8 ± 0.15	0.8 ± 0.15	T / L
	2.2μF	K: ± 10% / M: ± 20%	16	CM105X5R225 □ 16A#	12.5	1.6 ± 0.10	0.8 ± 0.10	0.8 ± 0.10	T / L
	4.7μF	K: ± 10% / M: ± 20%	25	CM105X5R475 □ 25A#	12.5	1.6 ± 0.20	0.8 ± 0.20	0.8 ± 0.20	T / L
	10μF	K: ± 10% / M: ± 20%	10	CM105X5R106 □ 10A#	12.5	1.6 ± 0.15	0.8 ± 0.15	0.8 ± 0.15	T / L
X7R	1μF	K: ± 10% / M: ± 20%	25	CM105X5R106 □ 25A#	15.0	1.6 ± 0.20	0.8 ± 0.20	0.8 ± 0.20	T / L
	1μF	K: ± 10% / M: ± 20%	16	CM105X7R105 □ 16A#	12.5	1.6 ± 0.10	0.8 ± 0.10	0.8 ± 0.10	T / L
	2.2μF	K: ± 10% / M: ± 20%	10	CM105X7R105 □ 10A#	12.5	1.6 ± 0.10	0.8 ± 0.10	0.8 ± 0.10	T / L
	2.2μF	K: ± 10% / M: ± 20%	6.3	CM105X7R225 □ 06A#	12.5	1.6 ± 0.15	0.8 ± 0.15	0.8 ± 0.15	T / L

General CM21 Series Size (JIS Code) : 0805(2012) # Packaging Code (Packaging quantity) : T(3,000pcs.) / L(10,000pcs.)

Dielectric code	Capacitance	□:Tolerance	Voltage [V]	Part Number	Tan δ [%]	Dimension			# Packaging Code (quantity)
						L[mm]	W[mm]	T[mm]	
X5R	1μF	K: ± 10% / M: ± 20%	50	CM21X5R105 □ 50A#	12.5	2.0 ± 0.10	1.25 ± 0.10	1.25 ± 0.10	T / L
			25	CM21X5R105 □ 25A#	5.0	2.0 ± 0.10	1.25 ± 0.10	1.25 ± 0.10	T / L
	2.2μF	K: ± 10% / M: ± 20%	25	CM21X5R225 □ 25A#	12.5	2.0 ± 0.20	1.25 ± 0.20	1.25 ± 0.20	T / L
			16	CM21X5R225 □ 16A#	5.0	2.0 ± 0.10	1.25 ± 0.10	1.25 ± 0.10	T / L
	4.7μF	K: ± 10% / M: ± 20%	25	CM21X5R475 □ 25A#	12.5	2.0 ± 0.20	1.25 ± 0.20	1.25 ± 0.20	T / L
			16	CM21X5R475 □ 16A#	12.5	2.0 ± 0.15	1.25 ± 0.15	1.25 ± 0.15	T / L
X7R			10	CM21X5R475 □ 10A#	7.0	2.0 ± 0.10	1.25 ± 0.10	1.25 ± 0.10	T / L
	10μF	K: ± 10% / M: ± 20%	16	CM21X5R106 □ 16A#	12.5	2.0 ± 0.20	1.25 ± 0.20	1.25 ± 0.20	T / L
			50	CM21X7R105 □ 50A#	5.0	2.0 ± 0.20	1.25 ± 0.20	1.25 ± 0.20	T / L
	1μF	K: ± 10% / M: ± 20%	25	CM21X7R105 □ 25A#	12.5	2.0 ± 0.10	1.25 ± 0.10	1.25 ± 0.10	T / L
			10	CM21X7R105 □ 10A#	5.0	2.0 ± 0.10	1.25 ± 0.10	1.25 ± 0.10	T / L
	2.2μF	K: ± 10% / M: ± 20%	25	CM21X7R225 □ 25A#	12.5	2.0 ± 0.20	1.25 ± 0.20	1.25 ± 0.20	T / L
	4.7μF	K: ± 10% / M: ± 20%	16	CM21X7R475 □ 16A#	12.5	2.0 ± 0.20	1.25 ± 0.20	1.25 ± 0.20	T / L
	10μF	K: ± 10% / M: ± 20%	6.3	CM21X7R106 □ 06A#	12.5	2.0 ± 0.20	1.25 ± 0.20	1.25 ± 0.20	T / L

General CM316 Series Size (JIS Code) : 1206(3216) # Packaging Code (Packaging quantity) : T(2,500pcs.) / L(5,000pcs.)

Dielectric code	Capacitance	□:Tolerance	Voltage [V]	Part Number	Tan δ [%]	Dimension			# Packaging Code (quantity)
						L[mm]	W[mm]	T[mm]	
X5R	2.2μF	K: ± 10% / M: ± 20%	100	CM316X5R225 □ 100A#	5.0	3.2 ± 0.20	1.6 ± 0.20	1.6 ± 0.20	T / L
			25	CM316X5R225 □ 25A#	5.0	3.2 ± 0.20	1.6 ± 0.15	1.6 ± 0.15	T / L
	4.7μF	K: ± 10% / M: ± 20%	50	CM316X5R475 □ 50A#	5.0	3.2 ± 0.20	1.6 ± 0.20	1.6 ± 0.20	T / L
			25	CM316X5R475 □ 25A#	5.0	3.2 ± 0.20	1.6 ± 0.15	1.6 ± 0.15	T / L
	10μF	K: ± 10% / M: ± 20%	25	CM316X5R106 □ 25A#	12.5	3.2 ± 0.20	1.6 ± 0.20	1.6 ± 0.20	T / L
			16	CM316X5R106 □ 16A#	5.0	3.2 ± 0.20	1.6 ± 0.15	1.6 ± 0.15	T / L
X7R			10	CM316X5R106 □ 10A#	7.0	3.2 ± 0.20	1.6 ± 0.15	1.6 ± 0.15	T / L
	22μF	K: ± 10% / M: ± 20%	16	CM316X5R226 □ 16A#	12.5	3.2 ± 0.20	1.6 ± 0.20	1.6 ± 0.20	T / L
	4.7μF	K: ± 10% / M: ± 20%	6.3	CM316X5R226 □ 06A#	7.5	3.2 ± 0.20	1.6 ± 0.20	1.6 ± 0.20	T / L
			50	CM316X7R475 □ 50A#	5.0	3.2 ± 0.20	1.6 ± 0.20	1.6 ± 0.20	T / L
	10μF	K: ± 10% / M: ± 20%	25	CM316X7R475 □ 25A#	12.5	3.2 ± 0.20	1.6 ± 0.20	1.6 ± 0.20	T / L
			25	CM316X7R106 □ 25A#	5.0	3.2 ± 0.20	1.6 ± 0.20	1.6 ± 0.20	T / L
			16	CM316X7R106 □ 16A#	12.5	3.2 ± 0.20	1.6 ± 0.20	1.6 ± 0.20	T / L
	22μF	K: ± 10% / M: ± 20%	10	CM316X7R226 □ 10A#	7.5	3.2 ± 0.20	1.6 ± 0.20	1.6 ± 0.20	T / L
			6.3	CM316X7R226 □ 06A#	12.5	3.2 ± 0.20	1.6 ± 0.20	1.6 ± 0.20	T / L
	X7S	2.2μF	K: ± 10% / M: ± 20%	100	CM316X7S225 □ 100A#	5.0	3.2 ± 0.20	1.6 ± 0.20	1.6 ± 0.20

General CM316 Series Size (JIS Code) : 1206(3216) # Packaging Code (Packaging quantity) : T(2,000pcs.)

Dielectric code	Capacitance	□:Tolerance	Voltage [V]	Part Number	Tan δ [%]	Dimension			# Packaging Code (quantity)
						L[mm]	W[mm]	T[mm]	
X7S	4.7μF	K: ± 10% / M: ± 20%	100	CM316X7S475 □ 100AT	5.0	3.2 ± 0.30	1.6 ± 0.30	1.6 ± 0.30	T

General CM32 Series Size (JIS Code) : 1210(3225) # Packaging Code (Packaging quantity) : T(1,000pcs.) / L(4,000pcs.)

Dielectric code	Capacitance	□:Tolerance	Voltage [V]	Part Number	Tan δ [%]	Dimension			# Packaging Code (quantity)
						L[mm]	W[mm]	T[mm]	
X5R	4.7μF	K: ± 10% / M: ± 20%	25	CM32X5R475 □ 25A#	5.0	3.2 ± 0.30	2.5 ± 0.20	2.5 ± 0.20	T / L
			50	CM32X5R106 □ 50A#	5.0	3.2 ± 0.30	2.5 ± 0.20	2.5 ± 0.20	T / L
	10μF	K: ± 10% / M: ± 20%	25	CM32X5R106 □ 25A#	12.5	3.2 ± 0.30	2.5 ± 0.20	2.5 ± 0.20	T / L
			16	CM32X5R106 □ 16A#	5.0	3.2 ± 0.30	2.5 ± 0.20	2.5 ± 0.20	T / L
	22μF	K: ± 10% / M: ± 20%	25	CM32X5R226 □ 25A#	12.5	3.2 ± 0.30	2.5 ± 0.20	2.5 ± 0.20	T / L
			16	CM32X5R226 □ 16A#	5.0	3.2 ± 0.30	2.5 ± 0.20	2.5 ± 0.20	T / L
X7R			10	CM32X5R226 □ 10A#	7.0	3.2 ± 0.30	2.5 ± 0.20	2.5 ± 0.20	T / L
	4.7μF	K: ± 10% / M: ± 20%	6.3	CM32X5R476 □ 06A#	7.5	3.2 ± 0.30	2.5 ± 0.20	2.5 ± 0.20	T / L
	4.7μF	K: ± 10% / M: ± 20%	16	CM32X7R475 □ 16A#	2.5	3.2 ± 0.30	2.5 ± 0.20	2.5 ± 0.20	T / L
	10μF	K: ± 10% / M: ± 20%	50	CM32X7R106 □ 50A#	5.0	3.2 ± 0.30	2.5 ± 0.20	2.5 ± 0.20	T / L
			25	CM32X7R106 □ 25A#	12.5	3.2 ± 0.30	2.5 ± 0.20	2.5 ± 0.20	T / L
	22μF	K: ± 10% / M: ± 20%	16	CM32X7R226 □ 16A#	12.5	3.2 ± 0.30	2.5 ± 0.20	2.5 ± 0.20	T / L



Part Number List



Low Profile CT03Series Size (JIS Code) : 0201(0603) # Packaging Code (Packaging quantity) : H(15,000pcs.) / N(50,000pcs.) / Q(30,000pcs.) / W(150,000pcs.)

Dielectric code	Capacitance	□:Tolerance	Voltage [V]	Part Number	Tan δ [%]	Dimension			# Packaging Code (quantity)
						L[mm]	W[mm]	T[mm]	
X5R	100nF	K: ± 10% / M: ± 20%	6.3	CT03X5R104 □ 06A#022	12.5	0.6 ± 0.03	0.3 ± 0.03	0.22max	H / N / Q / W
	1μF	M: ± 20%	6.3	CT03X5R105M06AH025	12.5	0.6 ± 0.09	0.3 ± 0.09	0.25max	H

Low Profile CT05 Series Size (JIS Code) : 0402(1005) # Packaging Code (Packaging quantity) : H(10,000pcs.) / N(50,000pcs.) / Q(20,000pcs.) / W(100,000pcs.)

Dielectric code	Capacitance	□:Tolerance	Voltage [V]	Part Number	Tan δ [%]	Dimension			# Packaging Code (quantity)
						L[mm]	W[mm]	T[mm]	
X5R	1μF	M: ± 20%	6.3	CT05X5R105M06A#022	12.5	1.0 ± 0.05	0.5 ± 0.05	0.22max	H / N / Q / W
		K: ± 10% / M: ± 20%		CT05X5R105 □ 06A#033	12.5	1.0 ± 0.05	0.5 ± 0.05	0.33max	H / N / Q / W
	2.2μF	M: ± 20%	6.3	CT05X5R225M06A#033	12.5	1.0 ± 0.05	0.5 ± 0.05	0.33max	H / N / Q / W
	4.7μF	M: ± 20%	6.3	CT05X5R475M06AH033	15.0	1.0 ± 0.20	0.5 ± 0.20	0.33max	H

Low Profile CT105 Series Size (JIS Code) : 0603(1608) # Packaging Code (Packaging quantity) : T(4,000pcs.) / L(10,000pcs.)

Dielectric code	Capacitance	□:Tolerance	Voltage [V]	Part Number	Tan δ [%]	Dimension			# Packaging Code (quantity)
						L[mm]	W[mm]	T[mm]	
X5R	1μF	K: ± 10%/M: ± 20%	16	CT105X5R105 □ 16A#055	12.5	1.6 ± 0.10	0.8 ± 0.10	0.55max	T / L

Low Profile CT21 Series Size (JIS Code) : 0805(2012) # Packaging Code (Packaging quantity) : T(4,000pcs.) / L(10,000pcs.)

Dielectric code	Capacitance	□:Tolerance	Voltage [V]	Part Number	Tan δ [%]	Dimension			# Packaging Code (quantity)
						L[mm]	W[mm]	T[mm]	
X5R	1μF	K: ± 10% / M: ± 20%	25	CT21X5R105 □ 25A#095	5.0	2.0 ± 0.10	1.25 ± 0.10	0.95max	T / L
	2.2μF		50	CT21X5R225 □ 50A#095	5.0	2.0 ± 0.20	1.25 ± 0.20	0.95max	T / L
	4.7μF		16	CT21X5R475 □ 16A#095	12.5	2.0 ± 0.15	1.25 ± 0.15	0.95max	T / L

High-Q CU02 Series Size (JIS Code) : 01005(0402) # Packaging Code (Packaging quantity) : H(20,000pcs.) / N(80,000pcs.) / P(40,000pcs.)

Dielectric code CΔ	Capacitance	□:Tolerance	Voltage [V]	Part Number	Q	Dimension			# Packaging Code (quantity)
						L[mm]	W[mm]	T[mm]	
CG/CH	0.2pF	B: ± 0.1pF / C: ± 0.25pF	25	CU02C Δ R20 □ 25A#	404	0.4 ± 0.02	0.2 ± 0.02	0.2 ± 0.02	H / N / P
			16	CU02C Δ R20 □ 16A#	404	0.4 ± 0.02	0.2 ± 0.02	0.2 ± 0.02	H / N / P
			25	CU02C Δ R20 □ 25A#	410	0.4 ± 0.02	0.2 ± 0.02	0.2 ± 0.02	H / N / P
	0.5pF	B: ± 0.1pF / C: ± 0.25pF	16	CU02C Δ R50 □ 16A#	410	0.4 ± 0.02	0.2 ± 0.02	0.2 ± 0.02	H / N / P
			25	CU02C Δ 1R0 □ 25A#	420	0.4 ± 0.02	0.2 ± 0.02	0.2 ± 0.02	H / N / P
	1pF	B: ± 0.1pF / C: ± 0.25pF	16	CU02C Δ 1R0 □ 16A#	420	0.4 ± 0.02	0.2 ± 0.02	0.2 ± 0.02	H / N / P
			25	CU02C Δ 1R5 □ 25A#	430	0.4 ± 0.02	0.2 ± 0.02	0.2 ± 0.02	H / N / P
	1.5pF	B: ± 0.1pF / C: ± 0.25pF	16	CU02C Δ 1R5 □ 16A#	430	0.4 ± 0.02	0.2 ± 0.02	0.2 ± 0.02	H / N / P
			25	CU02C Δ 2R0 □ 25A#	440	0.4 ± 0.02	0.2 ± 0.02	0.2 ± 0.02	H / N / P
	2pF	B: ± 0.1pF / C: ± 0.25pF	16	CU02C Δ 2R0 □ 16A#	440	0.4 ± 0.02	0.2 ± 0.02	0.2 ± 0.02	H / N / P
			25	CU02C Δ 3R0 □ 25A#	460	0.4 ± 0.02	0.2 ± 0.02	0.2 ± 0.02	H / N / P
	3pF	B: ± 0.1pF / C: ± 0.25pF	16	CU02C Δ 3R0 □ 16A#	460	0.4 ± 0.02	0.2 ± 0.02	0.2 ± 0.02	H / N / P
			25	CU02C Δ 4R0 □ 25A#	480	0.4 ± 0.02	0.2 ± 0.02	0.2 ± 0.02	H / N / P
	4pF	B: ± 0.1pF / C: ± 0.25pF	16	CU02C Δ 4R0 □ 16A#	480	0.4 ± 0.02	0.2 ± 0.02	0.2 ± 0.02	H / N / P
			25	CU02C Δ 5R0 □ 25A#	500	0.4 ± 0.02	0.2 ± 0.02	0.2 ± 0.02	H / N / P
	5pF	B: ± 0.1pF / C: ± 0.25pF	16	CU02C Δ 5R0 □ 16A#	500	0.4 ± 0.02	0.2 ± 0.02	0.2 ± 0.02	H / N / P
			25	CU02C Δ 6R0 □ 25A#	520	0.4 ± 0.02	0.2 ± 0.02	0.2 ± 0.02	H / N / P
	6pF	C: ± 0.25pF / D: ± 0.5pF	16	CU02C Δ 6R0 □ 16A#	520	0.4 ± 0.02	0.2 ± 0.02	0.2 ± 0.02	H / N / P
			25	CU02C Δ 7R0 □ 25A#	540	0.4 ± 0.02	0.2 ± 0.02	0.2 ± 0.02	H / N / P
	7pF	C: ± 0.25pF / D: ± 0.5pF	16	CU02C Δ 7R0 □ 16A#	540	0.4 ± 0.02	0.2 ± 0.02	0.2 ± 0.02	H / N / P
			25	CU02C Δ 8R0 □ 25A#	560	0.4 ± 0.02	0.2 ± 0.02	0.2 ± 0.02	H / N / P
	8pF	C: ± 0.25pF / D: ± 0.5pF	16	CU02C Δ 8R0 □ 16A#	560	0.4 ± 0.02	0.2 ± 0.02	0.2 ± 0.02	H / N / P
			25	CU02C Δ 9R0 □ 25A#	580	0.4 ± 0.02	0.2 ± 0.02	0.2 ± 0.02	H / N / P
	9pF	C: ± 0.25pF / D: ± 0.5pF	16	CU02C Δ 9R0 □ 16A#	580	0.4 ± 0.02	0.2 ± 0.02	0.2 ± 0.02	H / N / P
			25	CU02C Δ 100 □ 25A#	600	0.4 ± 0.02	0.2 ± 0.02	0.2 ± 0.02	H / N / P
	10pF	J: ± 5% / K: ± 10%	16	CU02C Δ 100 □ 16A#	600	0.4 ± 0.02	0.2 ± 0.02	0.2 ± 0.02	H / N / P
			25	CU02C Δ 120 □ 25A#	640	0.4 ± 0.02	0.2 ± 0.02	0.2 ± 0.02	H / N / P
	12pF	J: ± 5% / K: ± 10%	16	CU02C Δ 120 □ 16A#	640	0.4 ± 0.02	0.2 ± 0.02	0.2 ± 0.02	H / N / P
			25	CU02C Δ 150 □ 25A#	700	0.4 ± 0.02	0.2 ± 0.02	0.2 ± 0.02	H / N / P
	15pF	J: ± 5% / K: ± 10%	16	CU02C Δ 180 □ 16A#	760	0.4 ± 0.02	0.2 ± 0.02	0.2 ± 0.02	H / N / P
	18pF			CU02C Δ 180 □ 16A#	760	0.4 ± 0.02	0.2 ± 0.02	0.2 ± 0.02	H / N / P
	22pF			CU02C Δ 220 □ 16A#	840	0.4 ± 0.02	0.2 ± 0.02	0.2 ± 0.02	H / N / P

Three Terminal Capacitors KNH05 Series Size (JIS Code) : 0402(1005) Packaging Code (Packaging quantity) : H(10,000pcs.)

Dielectric code	Capacitance	□:Tolerance	Voltage [V]	Part Number	Tan δ [%]	Dimension			# Packaging Code (quantity)
						L[mm]	W[mm]	T[mm]	
X5R	4.3μF	M: ± 20%	4	KNH05X5R435M04AH	-	1.0 ± 0.10	0.5 ± 0.20	0.50 max	H
	10μF			KNH05X5R106M04AH		1.0 ± 0.20	0.5 ± 0.20	0.5 ± 0.20	H
	15μF			KNH05X5R156M04AH		1.0 ± 0.15	0.5 ± 0.15	0.5 ± 0.15	H



1. Specifications described in this catalog are for references. Products specifications shall be based on written documents agreed by each party.
2. Contents in this catalog are subject to change without notice. It is recommended to confirm the latest information at the time of usage. Also, Kyocera Electronic Components Catalog is revised once a year. We may not be able to accept requests based on old catalogs.
3. Products in this catalog are intended to be used in general electronic equipment such as office equipment, audio and visual equipment, communication equipment, measurement instrument and home appliances. It is absolutely recommended to consult with our sales representatives in advance upon planning to use our products in applications which require extremely high quality and reliability such as aircraft and aerospace equipment, traffic systems, safety systems, power plant and medical equipment including life maintenance systems.
4. Even though we strive for improvements of quality and reliability of products, it is requested to design with enough safety margin in equipment or systems in order not to threaten human lives directly or damage human bodies or properties by an accidental result of products.
5. It is requested to design based on guaranteed specifications for such as maximum ratings, operating voltage and operating temperature. It is not the scope of our guarantee for unsatisfactory results due to misuse or inadequate usage of products in the catalog.
6. Operation summaries and circuit examples in this catalog are intended to explain typical operation and usage of the product. It is recommended to perform circuit and assembly design considering surrounding conditions upon using products in this catalog.
7. Technical information described in this catalog is meant to explain typical operations and applications of products, and it is not intended to guarantee or license intellectual properties or other industrial rights of the third party or Kyocera.
8. Trademarks, logos and brand names used in this catalog are owned by Kyocera or the corresponding third party.
9. Certain products in this catalog are subject to the Foreign Exchange and Foreign Trade Control Act of Japan, and require the license from Japanese Government upon exporting the restricted products and technical information under the law.
Besides, it is requested not to use products and technical information in the catalog for the development and/or manufacture of weapons of mass destruction or other conventional weapons, nor to provide them to any third party with the possibility of having such purposes.
10. It is prohibited to reprint and reproduce a part or whole of this catalog without permission.
11. Contents described herein are as of December 2018.



■ Kyocera Products Sales Offices

Japan

■ HEADQUARTERS

KYOCERA Corporation

6 Takeda, Tobadono-cho, Fushimi-ku, Kyoto 612-8501, Japan

Phone: (81)-(75)604-3500

International Sales Division:

Phone: (81)-(75)604-3424

Fax: (81)-(75)604-3425

■ Contact Information

<https://global.kyocera.com/prdct/electro/contact/officelist.html>



Design Tool Introduction

Part Number, environmental documents, and other data can be searched with cap value, case size, or electrical characteristic of MLCC.

<http://prdct-search.kyocera.co.jp/electro-mlcc-en/>

